

Theo  
chương trình  
tiếng Anh mới  
của Bộ GD & ĐT

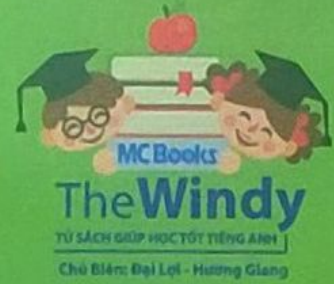

# Tuyển Tập Đề Thi VIOLYMPIC Tiếng Anh

LỚP 4  
Tập 1



MCBooks  
Chuyên sách ngoại ngữ

CD-Audio  
LUYỆN NGHE



ĐH  
QG  
Hà Nội

NHÀ XUẤT BẢN  
ĐẠI HỌC QUỐC GIA HÀ NỘI



# ROUND 1

## TEST A

**Exercise 1: Choose the correct answer. (Chọn đáp án đúng).**

- ..... are you from? – I'm from America.  
a. What                      b. How                      c. Nice                      d. Where
- Tom: Where ..... Peter from? Emily: He's from London.  
a. is                      b. am                      c. are                      d. do
- Tom is my ..... too.  
a. he                      b. she                      c. friend                      d. be
- Select the odd one out.  
a. She                      b. My                      c. He                      d. I
- Choose the odd one out.  
a. His                      b. Her                      c. Name                      d. Its
- There ..... ten desks in my classroom.  
a. is                      b. am                      c. are                      d. isn't
- That is my ..... His name is Minh.  
a. ten                      b. pen                      c. friend                      d. and
- ..... do you have Science? – On Monday.  
a. What                      b. When                      c. Why                      d. Who
- This is a ..... book.  
a. on                      b. red                      c. is                      d. this
- Let's colour ..... write.  
a. but                      b. and                      c. bye                      d. see



**Exercise 2: Put missing letters or a word to complete these sentences. (Điền chữ cái hoặc từ còn thiếu để hoàn thành câu).**





- She is \_ student.
- Tom: Where is Minh from? Jean: \_ \_ is from Ha Noi.
- Apple juice is my favourite d\_ ink.
- A: \_ \_ \_ old are you? B: I'm ten years old.

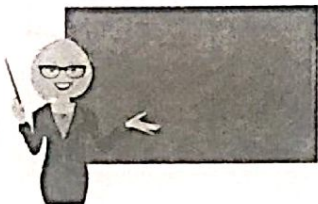
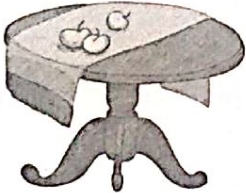
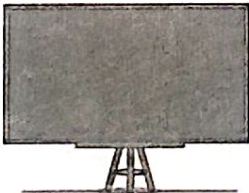

5. A: How old are \_\_\_? B: I'm six years old.
6. I like orange jui\_e.
7. Tim: How \_\_\_ is Hung? Tommy: He is 12 years old.
8. Can you do the pu\_zle?
9. That boy is my classmate. \_\_\_ name is Peter.
10. She is a te\_cher

**Exercise 3: Match each picture with a suitable word/ phrase.**  
(Nối tranh với từ/ cụm từ thích hợp).



	PICTURE		WORD/ PHRASE
1		a	chicken
2		b	sun
3		c	yo yo
4		d	apple
5		e	board



6		f	table
7		g	mirror
8		h	lamp
9		i	cat
10		j	teacher

*Your answers*

1.	3.	5.	7.	9.
2.	4.	6.	8.	10.

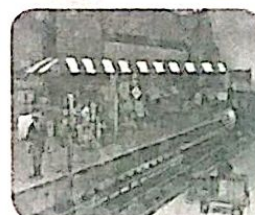
**Exercise 4: Listen and tick the correct photo.** (Nghe và chọn hình đúng).  
(Track 2)

	a	b	c	d
1				

2				
3				
4				
5	 kangaroo			
6				
7				
8				
9				
10				



## TEST B

**Exercise 1: Choose the correct answer.** (Chọn đáp án đúng).

- A: What colour is this? B: It's .....  
a. book                      b. a green                      c. green                      d. pencil
- A: Where ..... you from? B: I'm from Laos.  
a. is                      b. are                      c. am                      d. do
- Who ..... she?  
a. are                      b. is                      c. he                      d. how
- How's ..... weather today? – It's hot today.  
a. a                      b. an                      c. the                      d. my
- ..... you have pets? – Yes, I have a dog.  
a. Do                      b. Are                      c. Is                      d. What
- That is my .....  
a. friend                      b. he                      c. look                      d. bye
- Nice to meet .....  
a. me                      b. they                      c. he                      d. you
- Where ..... he from? – He's from England.  
a. is                      b. are                      c. and                      d. there
- I ..... many toys.  
a. have                      b. good                      c. see                      d. no
- A: How ..... is Nam? B: He's 12 years old.  
a. year                      b. years                      c. old                      d. olds

**Exercise 2: Put missing letters or a word to complete these sentences.**

(Điền chữ cái hoặc từ còn thiếu để hoàn thành câu).







- A: How are you? B: I'm fine, thank \_\_\_\_.
- Apple juice is my favourite d\_ink.
- She \_\_ from Hanoi.
- Do you want bread? - \_\_, I do not.
- Hello, I \_\_ Mai.
- \_\_\_\_\_ morning, Miss Hoa.
- Open the b\_x, please.





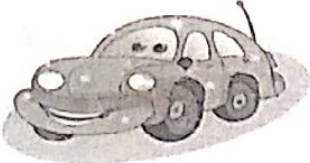

8. I am thir\_ty. I want some milk.
9. There are eleven desks \_\_ my classroom.
10. Sit \_ \_ \_ \_ , please.

**Exercise 3: Match each picture with a suitable word/ phrase. (Nối tranh với từ/ cụm từ thích hợp).**









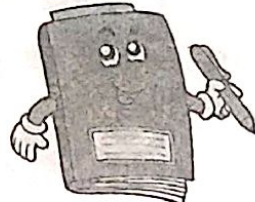
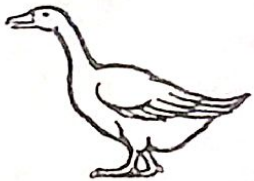

	PICTURE		WORD/ PHRASE
1		a	pineapple
2		b	car
3		c	balloon
4		d	orange
5		e	notebook
6		f	sofa
7		g	dog

8		h	school bag
9		i	chair
10		j	question

Your answers

1.	3.	5.	7.	9.
2.	4.	6.	8.	10.

**Exercise 4: Listen and tick the correct photo.** (Nghe và chọn hình đúng).  
(Track 3)

	a	b	c	d
1				
2				
3				







4				
5				
6				
7				
8				
9				
10				



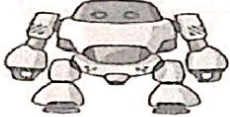

# ROUND 2

## TEST A

**Exercise 1: Match each picture with a suitable word/ phrase. (Nối tranh với từ/ cụm từ thích hợp).**

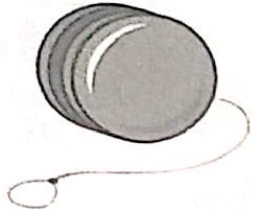
	PICTURE		WORD/ PHRASE
1		a	fire
2		b	yo yo
3		c	lion
4		d	windy
5		e	mother
6		f	robot



7		g	guitar
8		h	motorbike
9		i	bat
10		j	cat

*Your answers*

1.	3.	5.	7.	9.
2.	4.	6.	8.	10.

**Exercise 2: Put missing letters or a word to complete these sentences.**  
 (Điền chữ cái hoặc từ còn thiếu để hoàn thành câu).

- I am fi\_ \_ , thanks.
- I'm 7 years o\_ \_ .
- How \_ \_ r you? – I'm fine, thanks.
- That's \_ y friend.
- Hello, \_ 'm Peter.
- Your sch\_ \_ \_ is big.



- 7. What col\_\_r is it? – It's green.
- 8. Cl\_\_e your book.
- 9. What's her \_\_\_e? – Her name is Mary.
- 10. Write the sent\_\_ces.

**Exercise 3: Reorder the words/ phrases to make complete sentences.**  
 (Sắp xếp lại từ hoặc cụm từ để tạo thành câu hoàn chỉnh).

- 1. How/ are/ you?/ old  
.....
- 2. What/ your/ is/ name?  
.....
- 3. has/ two/ brothers./ Mary  
.....
- 4. is/ from/ Peter/ Australia.  
.....
- 5. sister/ friend./ is/ my/ Her  
.....
- 6. is/ a/ big/ box./ It  
.....
- 7. many birds/ in/ There/ the tree./ are  
.....
- 8. is/ my/ Lan Anh/ friend./ best  
.....
- 9. girl/ That/ is/ Lan.  
.....
- 10. my/ Linda/ friends./ are/ and Peter.  
.....





**Exercise 4: Listen and choose what you hear** (Nghe và chọn phương án em nghe thấy). (track 4)





1.
  - a. He's Mr. Bill
  - b. He's teacher Bean.
  - c. He's Mr. Bean
  - d. He's doctor Bean.
2.
  - a. That is my teacher.
  - b. This is my father.
  - c. This is my sister.
  - d. This is my brother.
3.
  - a. Where are you from?
  - b. Where is she from?
  - c. Where are they from?
  - d. Where are you now?
4.
  - a. How are you, Griffin?
  - b. How are you, Miss Kim?
  - c. How old are you, Bill?
  - d. How old are you, Griffin?
5.
  - a. I'm Asimo.
  - b. I'm Akio.
  - c. I'm Leo.
  - d. I'm Mido.
6.
  - a. doctor
  - b. mister
  - c. teacher
  - d. sister
7.
  - a. I'm hot.
  - b. I'm bored.
  - c. I'm short.
  - d. I'm Bob.
8.
  - a. mouse
  - b. house
  - c. how
  - d. cow
9.
  - a. I'm from Scotland.
  - b. I'm from Holland.
  - c. I'm from Finland.
  - d. I'm from England.
10.
  - a. teacher
  - b. brother
  - c. sister
  - d. father





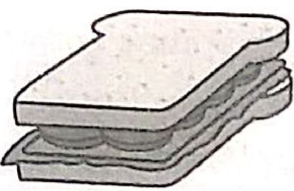

**TEST B**

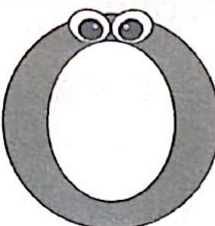
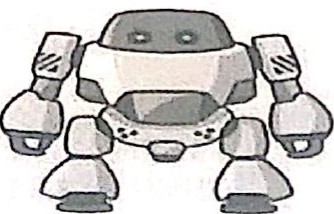
**Exercise 1: Match each picture with a suitable word/ phrase. (Nối tranh với từ/ cụm từ thích hợp).**

	PICTURE		WORD/ PHRASE
1		a	zero
2		b	tiger
3		c	lion
4		d	ladder
5		e	box
6		f	sandwich



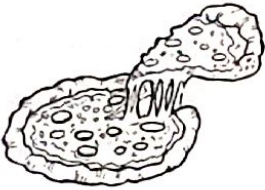
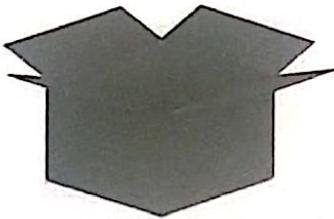

7		g	yo yo
8		h	cat
9		i	pizza
10		j	robot

Your answers

1.	3.	5.	7.	9.
2.	4.	6.	8.	10.

**Exercise 2: Put missing letters or a word to complete these sentences.**  
 (Điền chữ cái hoặc từ còn thiếu để hoàn thành câu).

1. \_\_w old are you?
2. He's ten years o\_\_.
3. Thank you very m\_\_h.
4. The doll is very nice t\_y.
5. Let's cou\_t the clouds.
6. The doll \_s very nice.
7. I'm from Vietnam. A\_d you?



8. I am \_rom Singapore.
9. There's \_ bedroom in my house.
10. Is \_ \_ \_s your school?

**Exercise 3: Reorder the words/ phrases to make complete sentences.**  
(Sắp xếp lại từ hoặc cụm từ để tạo thành câu hoàn chỉnh).

1. are/ how/ Hello,/ you?  
.....
2. Would/ some/ like/ milk?/ you  
.....
3. sister?/ your/ How/ is/ old  
.....
4. can/ She/ jump/ rope.  
.....
5. is/ What/ he/ doing?  
.....
6. my/ is/ room./ This  
.....
7. is/ old/ How/ she?  
.....
8. very/ is/ She/ hungry.  
.....
9. you?/ How/ are/ old  
.....
10. cats./ Mary/ has/ two  
.....

**Exercise 4: Listen and choose what you hear** (Nghe và chọn phương án em nghe thấy).(Track 5)

1.
 

a. Let's play volleyball.	b. Let's play football.
c. Let's play basketball.	d. Let's play golf.







2. a. Good morning, Holmes!  
c. Good morning, Tony!
3. a. Pet's room      b. Bathroom      c. Big room      d. Bedroom
4. a. That is my teacher.  
c. This is my sister.
5. a. Dining room      b. Meeting room  
c. Swimming pool      d. Living room
6. a. He is fine.      b. He is right.      c. He is nice.      d. He is nine.
7. a. My new pen is orange.  
c. My new friend is Peter.
8. a. Where are you from?  
c. Where are they from?
9. a. teacher      b. brother      c. sister      d. father
10. a. I'm hot.      b. I'm bored.      c. I'm short.      d. I'm Bob.

### ROUND 3





### TEST A

**Exercise 1: Choose the correct answer.** (Chọn đáp án đúng).



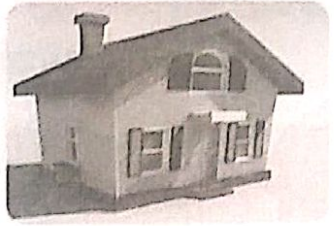

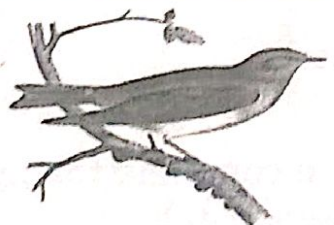
1. Is this a book?  
a. Yes, it's not.      b. Yes, it.      c. Yes, it is.      d. Yes, it isn't.
2. There ..... two chairs in my classroom.  
a. is      b. be      c. are      d. do

3. This birthday cake is ..... you.  
 a. for                      b. on                      c. of                      d. to
4. How are you? - .....  
 a. I'm nice                      b. I'm happy  
 c. I'm fine, thanks                      d. I'm good, thanks

**Exercise 2: Match each picture with a suitable word/ phrase. (Nối tranh với từ/ cụm từ thích hợp).**

	PICTURE		WORD/ PHRASE
1		a	calendar
2		b	house
3		c	paper
4		d	banana
5		e	numbers

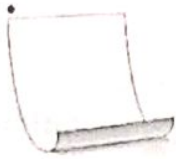
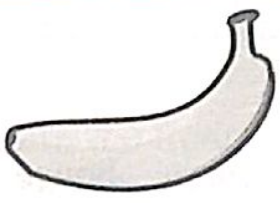

6		f	carrot
7		g	telephone
8		h	sandwich
9		i	orange
10		j	bird

Your answers















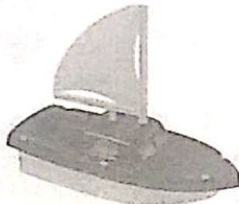

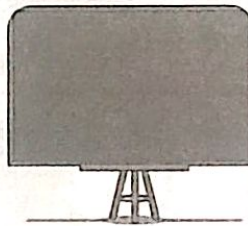

1.	3.	5.	7.	9.
2.	4.	6.	8.	10.

**Exercise 3: Put missing letters or a word to complete these sentences**  
 (Điền chữ cái hoặc từ còn thiếu để hoàn thành câu).

- Where are you f\_\_m?
- Goodbye. S\_\_ you later.
- He's ten years o\_\_.
- A: How's the weat\_\_r today? B: It's very hot today.
- This gi\_t is for you.





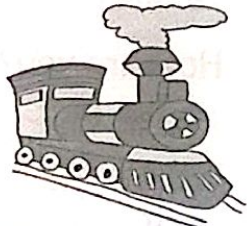

6. This \_\_ my teacher.
7. The cak\_ is for you.
8. How m\_ \_y clouds are there?
9. He is from Engl\_ \_d.
10. They are d\_ \_tors.

**Exercise 4: Listen and tick the correct photo.** (Nghe và chọn hình đúng).  
(Track 6)



	a	b	c	d
1				
2				
3				
4				
5				



**Exercise 2: Match each picture with a suitable word/ phrase. (Nối tranh với từ/ cụm từ thích hợp).**

	PICTURE		WORD/ PHRASE
1		a	ant
2		b	chicken
3		c	girl
4		d	ice-cream
5		e	calendar
6		f	school bus
7		g	pizza



8		h	taxi
9		i	teddy bear
10		j	monkey

Your answers















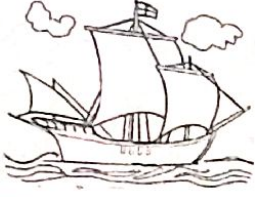

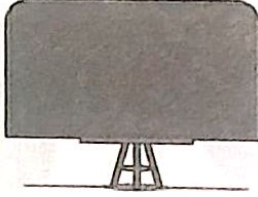



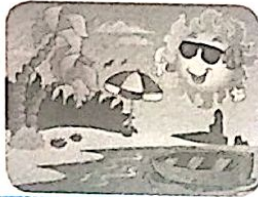



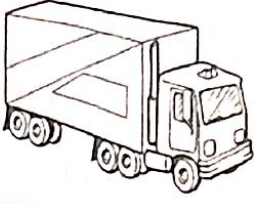

1.	3.	5.	7.	9.
2.	4.	6.	8.	10.

**Exercise 3: Put missing letters or a word to complete these words/ sentences.** (Điền chữ cái hoặc từ còn thiếu để hoàn thành từ/ câu).

1. CLASSRO\_M
2. AUGU\_T
3. My sister like\_ candy very much.
4. Goodbye, chi\_ \_ren. See you later.
5. T\_ANK
6. Mary is hap\_y because today is her birthday.
7. Goodbye. See you tomorr\_w.
8. Is your ro\_m big?
9. There are m\_ \_y pens in my school bag.
10. SUMMAR\_

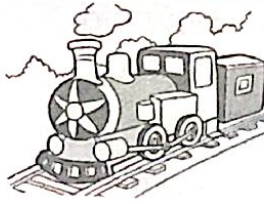

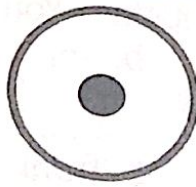
**Exercise 4: Listen and tick the correct photo. (Nghe và chọn hình đúng).**  
(Track 7)

	a	b	c	d
1				
2				
3				
4				
5				
6				
7				





Idea

8				
9				
10				

## ROUND 4

### TEST A

**Exercise 1: Choose the correct answer. (Chọn đáp án đúng).**

- This ..... my friend, Nga.  
a. am                      b. is                      c. are                      d. name
- Give ..... a pen, please.  
a. my                      b. my's                      c. me                      d. i
- How old ..... you, Mary? – I'm ten years old.  
a. am                      b. is                      c. are                      d. years
- Listen ..... the teacher, please.  
a. at                      b. on                      c. to                      d. in
- Thank you very much. – You ..... welcome.  
a. is                      b. am                      c. are                      d. isn't
- Where are you .....? – I'm from Japan.  
a. is                      b. from                      c. go                      d. old









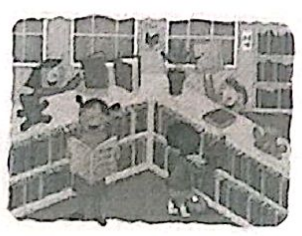

7. Tommy is my friend. He is a ..... at Quang Trung Primary School.  
 a. worker                      b. doctor                      c. farmer                      d. student
8. I ..... sorry. I'm late.  
 a. is                      b. are                      c. am                      d. not
9. There is ..... dog in my house.  
 a. a                      b. are                      c. two                      d. is
10. Draw ..... picture, please.  
 a. a                      b. an                      c. a's                      d. an's

**Exercise 2: Put missing letters or a word to complete these sentences.**  
 (Điền chữ cái hoặc từ còn thiếu để hoàn thành câu).

1. I \_\_ sorry. I'm late.
2. Tha\_\_ you very much.
3. This cak\_ is for you. – Thank you very much.
4. There is a TV \_\_ the living room.
5. My mother is forty years \_\_\_\_.
6. My sister is a student at Hoang Mai Primary Sch \_\_\_\_.
7. Thang is a student at Dong Da Prima\_y School.
8. Hello, I am Alan. How are you? – I'm fine, thanks. \_\_\_ you?
9. These crayons a\_\_ for you. – Thank you very much.
10. Open the book and r\_\_d after me, please.

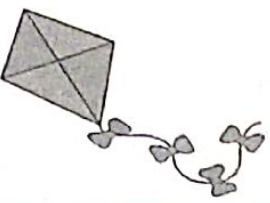
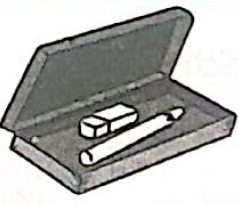
**Exercise 3: Match each picture with a suitable word/ phrase.** (Nối tranh với từ/ cụm từ thích hợp).

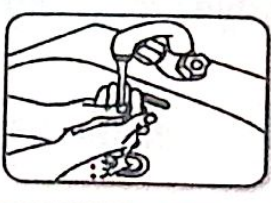
	PICTURE		WORD/ PHRASE
1		a	wash hands

2		b	drink
3		c	car
4		d	pencil box
5		e	bathroom
6		f	library
7		g	grape
8		h	call
9		i	duck



10		j	kite
----	---	---	------

Your answers

1.	3.	5.	7.	9.
2.	4.	6.	8.	10.

**Exercise 4: Listen and choose what you hear (Nghe và chọn phương án em nghe thấy). (Track 8)**

1.
 

a. She likes dancing.	b. She likes drawing.
c. She likes cooking.	d. She likes driving.
2.
 

a. Who is he?	b. Who is that?	c. Who is this?	d. Who is it?
---------------	-----------------	-----------------	---------------
3.
 

a. Music club	b. Music box	c. Musician	d. Music note
---------------	--------------	-------------	---------------
4.
 

a. Lee likes watching TV.	b. Bean likes watching TV.
c. He likes watching TV.	d. She likes watching TV.
5.
 

a. We go together.	b. We have two brothers.
c. We have three brothers.	d. We have two sisters.
6.
 

a. He is five.	b. He is nice.	c. He is nine.	d. He is fine.
----------------	----------------	----------------	----------------
7.
 

a. It's in October.	b. It's in September.
c. It's in November.	d. It's in December.
8.
 

a. When's your birthday?	b. When's his birthday?
c. When was the birthday?	d. When is her birthday?
9.
 

a. The weather is nice here.
b. The weather is nice and sunny here.











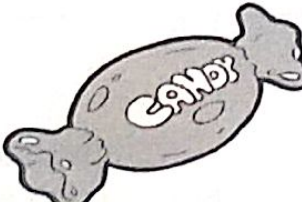



2. Happy birthday, Phong. This gift is \_\_\_ \_ you.
3. \_\_\_ \_ the ruler red?
4. \_\_\_ \_ \_ is your birthday? – It's in February.
5. Hai is \_ student at Dong Da Primary School.
6. W\_ \_ n is your birthday?
7. How old \_\_\_ your sister? – She is eleven years old.
8. My m\_ther's birthday is in May.
9. There are two bedroom\_ in my house.
10. Where is Jean from? – She is f\_ \_ m France.

**Exercise 3: Match each picture with a suitable word/ phrase. (Nối tranh với từ/ cụm từ thích hợp).**

	PICTURE		WORD/ PHRASE
1		a	ruler
2		b	car
3		c	kite
4		d	dance

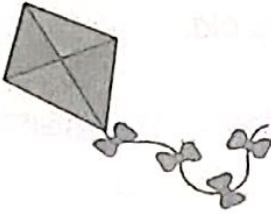
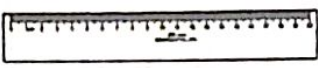



5		e	smile
6		f	teddy bear
7		g	tiger
8		h	candy
9		i	watch
10		j	butterfly

Your answers

1.	3.	5.	7.	9.
2.	4.	6.	8.	10.



**Exercise 4: Listen and choose what you hear** (Nghe và chọn phương án em nghe thấy). (Track 9)

1.
  - a. I like shopping.
  - b. I like dancing.
  - c. I like swimming.
  - d. I like swinging.
2.
  - a. When's your birthday?
  - b. When's his birthday?
  - c. When was the birthday?
  - d. When is her birthday?
3.
  - a. He drives a car.
  - b. He rides a camel.
  - c. She drives a car.
  - d. She rides a camel.
4.
  - a. My birthday is on Sunday.
  - b. My birthday is on Friday.
  - c. My birthday is today.
  - d. My birthday is in May.
5.
  - a. set up
  - b. wake up
  - c. get up
  - d. stand up
6.
  - a. I can draw.
  - b. I can dance.
  - c. I can ride.
  - d. I can drive.
7.
  - a. What's on today?
  - b. Which's the date today?
  - c. What's the date today?
  - d. What's the weather like today?
8.
  - a. book shop
  - b. bookshelf
  - c. cupboard
  - d. bookcase
9.
  - a. Can you draw a picture?
  - b. Can you draw a pig?
  - c. Can you drive a big car?
  - d. Can you draw a computer?
10.
  - a. I have a pencil case, too.
  - b. I have a pencil, too.
  - c. I have a grey pencil.
  - d. I have some pencils.













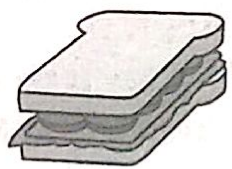

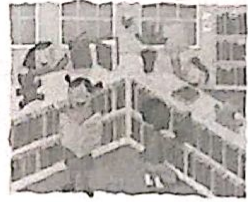
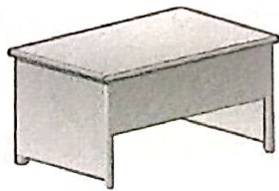
# ROUND 5

## TEST A

**Exercise 1: Match each picture with a suitable word/ phrase. (Nối tranh với từ/ cụm từ thích hợp).**

	PICTURE		WORD/ PHRASE
1		a	sandwich
2		b	desk
3		c	newspaper
4		d	school library
5		e	cat
6		f	classroom

7		g	violin
8		h	cow
9		i	tree
10		j	smile

Your answers

1.	3.	5.	7.	9.
2.	4.	6.	8.	10.

**Exercise 2: Reorder the words/ phrases to make complete sentences.**  
 (Sắp xếp lại từ hoặc cụm từ để tạo thành câu hoàn chỉnh).

- from/ America./ I/ am  
.....
- brother/ like/ My/ cat./ doesn't  
.....
- some/ Peter/ wants/ food.  
.....
- friend./ is/ Tom/ my  
.....
- an/ Would/ you/ like/ ice-cream?  
.....

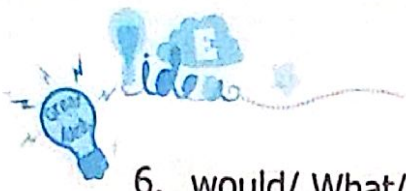

6. would/ What/ you/ like?

.....

7. in/ rainy/ July./ It's

.....

8. What/ job?/ is/ her

.....

9. chant/ aloud./ Read/ the

.....

10. Is/ this/ desk?/ a

.....

**Exercise 3: Pick out one redundant letter to make the correct word. (Bỏ một chữ cái thừa để có từ đúng).**





1. STASR
2. STUDENT
3. WHUERE
4. PLEARSE
5. BIARTHDAY
6. NOTESBOOK
7. WDOULD
8. TSREE
9. SCHOIOL
10. CANGDLE

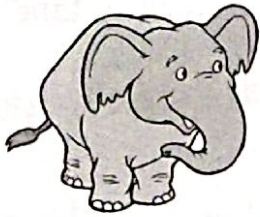

**Exercises 4: Listen and choose the correct answer. (Nghe và chọn đáp án đúng). (Track 10)**

1. My birthday is on .....
 

a. the first of October	b. the fifth of October
c. the first of September	d. the first of December

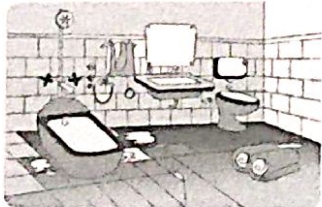
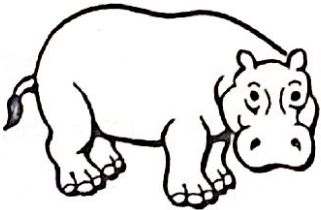

2		b	car
3		c	bathroom
4		d	elephant
5		e	mouse
6		f	earrings
7		g	hippo
8		h	train

9		i	bus
10		j	comb

*Your answers*

1.	3.	5.	7.	9.
2.	4.	6.	8.	10.

**Exercise 2: Reorder the words/ phrases to make complete sentences.**  
 (Sắp xếp lại từ hoặc cụm từ để tạo thành câu hoàn chỉnh).

1. I have/ in/ my bag./ a book  
 .....
2. is/ you./ doll/ This/ for  
 .....
3. England/ , too./ Jim/ is/ from  
 .....
4. When/ is/ birthday?/ father's/ your  
 .....
5. is/ robot./ This/ a  
 .....
6. is/ from/ Singapore./ She  
 .....
7. a/ this/ Is/ desk?  
 .....
8. morning,/ teacher!/ Good  
 .....



9. for/ gift/ you./ is/ This

10. hungry/ now./ am/ I

**Exercise 3: Pick out one redundant letter to make the correct word. (Chọn một chữ cái thừa để có từ đúng).**

1. BECAUTSE
2. FIGSH
3. HOUSYE
4. RSULER
5. LOEOK
6. PIENCIL
7. WHUERE
8. WHIUTE
9. NUMBWER
10. REAQD

**Exercises 4: Listen and choose the correct answer. (Nghe và chọn đáp án đúng). (Track 11)**

1. She comes from .....  
 a. England      b. America      c. Japan      d. Germany
2. We are going to the ..... tonight.  
 a. Physic club      b. Music club      c. English club      d. Football club
3. What ..... are you in?  
 a. class      b. flat      c. grade      d. group
4. I like .....  
 a. skipping      b. cooking      c. looking      d. surfing
5. Are you .....?  
 a. Spanish      b. English      c. Japanese      d. Korean
6. She likes listening to .....  
 a. English songs      b. Russian songs  
 c. Korean songs      d. Vietnamese songs





- 7. It's the ..... of October.  
a. first                      b. fifth                      c. sixth                      d. third
- 8. Do you like .....?  
a. reading                      b. feeding                      c. teaching                      d. kneeling
- 9. Are you .....?  
a. Spanish                      b. English                      c. Japanese                      d. Vietnamese
- 10. They're all ..... after school.  
a. well                      b. fine                      c. not bad                      d. tired

**ROUND 6**

**TEST A**





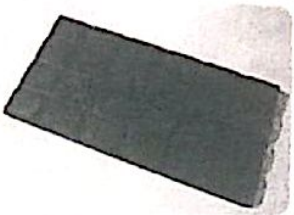

**Exercise 1: Put missing letters or a word to complete these sentences.**  
(Điền chữ cái hoặc từ còn thiếu để hoàn thành câu).

- 1. \_\_\_ you swim? – Yes, I can.
- 2. You sl\_\_p in the bedroom.
- 3. Che\_k the words you hear.
- 4. Can you play football? – No, I \_\_\_ not.

**Exercise 2: Match each picture with a suitable word/ phrase.** (Nối tranh với từ/ cụm từ thích hợp).

	PICTURE		WORD/ PHRASE
1		a	garden
2		b	monkey

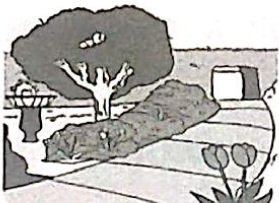

3		c	banana
4		d	chocolate
5		e	talk
6		f	flag
7		g	cow
8		h	butterfly
9		i	bus
10		j	bread









*Your answers*

1.	3.	5.	7.	9.
2.	4.	6.	8.	10.

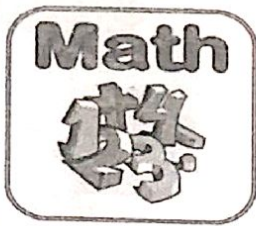
**Exercise 3: Pick out one redundant letter to make the correct word.** (Bỏ một chữ cái thừa để có từ đúng).

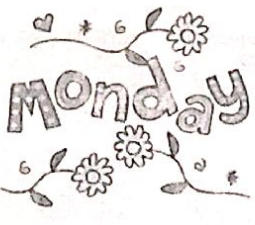
1. TABOLE
2. BECAUTSE
3. CAYKE
4. LIUKE
5. WHYM
6. WRICTE
7. SCHPOOL
8. BREAJD
9. STHAND
10. SWIMM

**Exercise 4: Listen and tick the correct photo.** (Nghe và chọn hình đúng).  
(Track 12)

	a	b	c	d
1				
2				





idea

3				
4				
5				
6				
7				
8				
9				
10				







# TEST B





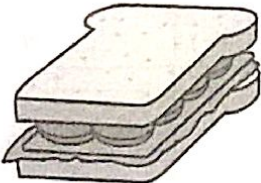

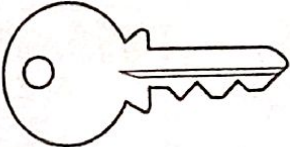
**Exercise 1: Put missing letters or a word to complete these sentences.**  
 (Điền chữ cái hoặc từ còn thiếu để hoàn thành câu).

1. Thang can play football \_\_\_ dance.
2. Wh\_ is that? – That’s my sister, Linda.
3. Reorde\_ the sentences.
4. Can you sing an English song? - \_\_\_\_, I can.

**Exercise 2: Match each picture with a suitable word/ phrase.** (Nối tranh với từ/ cụm từ thích hợp).

	PICTURE		WORD/ PHRASE
1		a	key
2		b	marker
3		c	orange
4		d	classroom



5		e	get up
6		f	sandwich
7		g	balloon
8		h	cake
9		i	raincoat
10		j	drum









Your answers

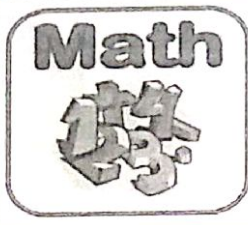

1.	3.	5.	7.	9.
2.	4.	6.	8.	10.

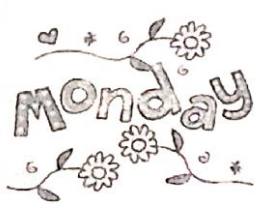
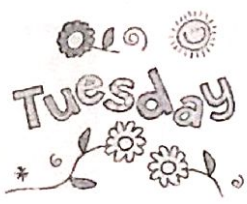
**Exercise 3: Pick out one redundant letter to make the correct word. (Bỏ một chữ cái thừa để có từ đúng).**

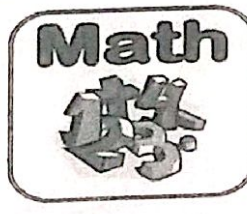
1. SIENG
2. FRIAEND
3. PIZYZA
4. SCHPOOL
5. DANCFE
6. WHIEN
7. PLAIY
8. LISTKEN
9. CANTNOT
10. VIETNAMMESE

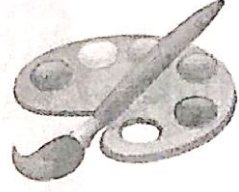
**Exercise 4: Listen and tick the correct photo. (Nghe và chọn hình đúng).**  
(Track 13)





	a	b	c	d
1				
2				
3				

4				
5				
6				
7				
8				
9				
10				

**ROUND 7**

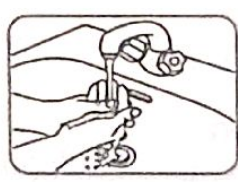
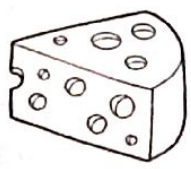

**TEST A**

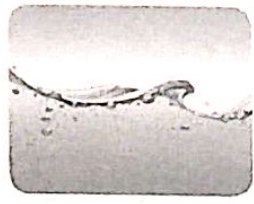
**Exercise 1: Match each picture with a suitable word/ phrase.** (Nối tranh với từ/ cụm từ thích hợp).

	PICTURE		WORD/ PHRASE
1		a	nose
2		b	tea
3		c	hands
4		d	jump rope
5		e	crocodile
6		f	ice cream



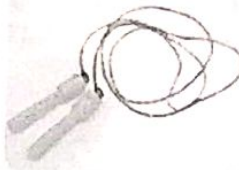

7		g	cheese
8		h	noisy
9		i	telephone
10		j	water

Your answers

1.	3.	5.	7.	9.
2.	4.	6.	8.	10.

**Exercise 2: Put missing letters or a word to complete these sentences.**  
 (Điền chữ cái hoặc từ còn thiếu để hoàn thành câu).

- I was born in Dec\_\_ber.
- How o\_\_ is your sister? – She's eight years old.
- This is my bedroom. \_\_ is not big.
- Stand \_\_ now and open your book.
- Is it a r\_\_nd box? – No, it is a square box.
- \_\_o is that? – She is my teacher.
- John is a st\_\_nt at Oxford Primary School.
- Can he p\_\_y football? – Yes, he can.
- I am \_\_om England.
- \_\_\_\_\_ is it? – It is a chair.



**Exercise 3: Choose the correct answer. (Chọn đáp án đúng).**

- I can ..... English.  
a. speaks      b. speak      c. to speak      d. speaking
- Would you like a .....? – No, thanks.  
a. banana      b. apple      c. ice cream      d. orange
- Is this a notebook? – No, .....  
a. it isn't      b. it is      c. it does      d. it doesn't
- This ruler is .....  
a. book      b. pen      c. small      d. bag
- His books are ..... the table.  
a. at      b. in      c. down      d. on
- ..... are you from? – I'm from New Zealand.  
a. Who      b. When      c. Where      d. How
- Where is she today? - .....  
a. She's at school      b. She's fine  
c. She's from Australia      d. She's seven years old
- Would you like ..... ice cream?  
a. a      b. an      c. some      d. the
- What do you do ..... Maths lessons?  
a. from      b. and      c. during      d. on
- I can speak .....  
a. Vietnam      b. England      c. America      d. English

**Exercises 4: Listen and choose the correct answer. (Nghe và chọn đáp án đúng). (Track 14)**

- What ..... are you in?  
a. group      b. grade      c. class      d. classroom
- Today is .....  
a. Monday      b. my day      c. Thursday      d. Sunday
- I have got Music on ..... and .....  
a. Sunday – Thursday      b. Sunday – Tuesday  
c. Monday – Thursday      d. Monday – Tuesday











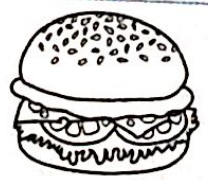

4. On Saturday, we go out for .....  
 a. breakfast      b. lunch      c. dinner      d. movie
5. ...., we play football.  
 a. On Saturday morning      b. On Sunday morning  
 c. On Thursday morning      d. On Tuesday morning
6. I have got Vietnamese ..... a week.  
 a. four times      b. five times      c. more times      d. twice
7. What is your favourite .....?  
 a. inject      b. subject      c. object      d. project
8. .... is ..... favourite subject.  
 a. Maths – Mai's      b. Arts – Mai's      c. Maths – my      d. Arts – my
9. Let's .....!  
 a. drive      b. ride      c. run      d. read
10. There is a ..... on the wall.  
 a. pink hat      b. big cat      c. pink map      d. big map

## TEST B

**Exercise 1: Match each picture with a suitable word/ phrase.** (Nối tranh với từ/ cụm từ thích hợp).

	PICTURE		WORD/ PHRASE
1		a	noisy
2		b	parrot
3		c	bicycle

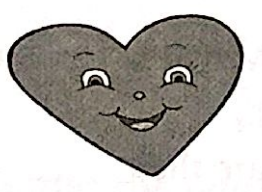
4		d	heart
5		e	tree
6		f	sleep
7		g	bee
8		h	play chess
9		i	cow
10		j	hamburger

**Your answers**

1.	3.	5.	7.	9.
2.	4.	6.	8.	10.



**Exercise 2: Put missing letters or a word to complete these sentences**  
(Điền chữ cái hoặc từ còn thiếu để hoàn thành câu).

1. Ha can dance b\_\_ cannot play football.
2. A cat can cl\_\_b a tree.
3. His sister is t\_\_ll but he is short.
4. Mary is in the cl\_\_\_\_\_m now.
5. I can r\_n with my legs.
6. I'd like \_\_ ice cream.
7. My father can s\_im.
8. Happy bi\_\_\_\_\_ay to you!
9. Please, give me some m\_\_e.
10. Can he p\_\_y football? – Yes, he can.

**Exercise 3: Choose the correct answer.** (Chọn đáp án đúng).

1. Where's Tommy .....? – He's from England.  
a. from                      b. come                      c. is                      d. on
2. He is ..... years old.  
a. fine                      b. nine                      c. nice                      d. kite
3. Choose the odd one out.  
a. Read                      b. Sing                      c. Draw                      d. Book
4. What's ..... name? – He's Tommy.  
a. her                      b. his                      c. he                      d. she
5. Can you swim? - .....  
a. No, I can                      b. No, thanks                      c. Yes, I can't                      d. Yes, I can
6. When is your birthday? - .....  
a. It's May                      b. It in May                      c. May it is                      d. It's in May
7. Are they students? – Yes, .....  
a. they are                      b. they do                      c. are they                      d. are their
8. Would you like ..... ice cream?  
a. a                      b. an                      c. some                      d. the
9. .... go to the cinema?  
a. Would                      b. Can                      c. When                      d. Let's





**Exercises 4: Listen and choose the correct answer.** (Nghe và chọn đáp án đúng). (Track 15)

1. I ..... English and Maths.  
a. love                      b. like                      c. find                      d. learn
2. Have you got ..... today?  
a. Physics                      b. Music                      c. English                      d. Maths
3. I ..... from Monday to Friday.  
a. go to work                      b. go to school                      c. go to the zoo                      d. go to the library.
4. What ..... have you got today?  
a. lectures                      b. lessons                      c. mission                      d. science
5. I don't have English on .....  
a. Monday                      b. Tuesday                      c. Friday                      d. Sunday
6. I ..... play badminton and volleyball.  
a. can                      b. can't                      c. don't                      d. case
7. ...., we play football.  
a. On Saturday morning                      b. On Sunday morning  
c. On Thursday morning                      d. On Tuesday morning
8. We don't ..... on Sunday evening.  
a. go to school                      b. go to shop                      c. go fishing                      d. go shopping
9. He has got four favourite .....  
a. subjects                      b. objects                      c. projects                      d. moon cakes
10. I have got a new ....., his name is .....  
a. roommate – Jim                      b. roommate – Tim  
c. classmate – Jim                      d. classroom – Tim

**ROUND 8**

**TEST A**



**Exercise 1: Reorder the words/ phrases to make complete sentences.** (Sắp xếp lại từ hoặc cụm từ để tạo thành câu hoàn chỉnh).





1. can/ fly./ bird/ A  
.....

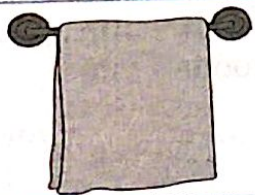

2. is/ in/ now./ the classroom/ Mary  
.....
3. am/ England./ I/ from  
.....
4. cannot/ Hung/ dance but/ play football./ can  
.....
5. sing/ an/ English/ song./ Let's  
.....
6. big or/ small?/ school/ your/ Is  
.....
7. This/ family./ is/ my  
.....
8. Mary/ speak/ can/ Vietnamese.  
.....
9. much./ like/ chocolate/ I/ very  
.....
10. sing./ can/ sister/ My  
.....

**Exercise 2: Match each picture with a suitable word/ phrase.** (Nối tranh với từ/ cụm từ thích hợp).

	PICTURE		WORD/ PHRASE
1		a	flower vase
2		b	cheeks
3		c	horse

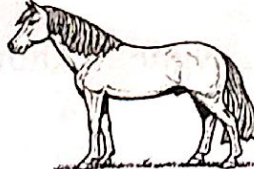
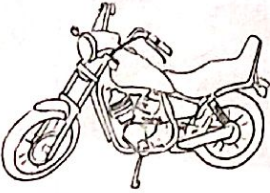
4		d	giraffe
5		e	sick
6		f	chocolate
7		g	towel
8		h	sad
9		i	motorbike
10		j	dance

Your answers

1.	3.	5.	7.	9.
2.	4.	6.	8.	10.













**Exercise 3: Choose the correct answer. (Chọn đáp án đúng).**

1. This banana is ..... you, Jim.  
 a. on                      b. for                      c. in                      d. under
2. Can you ..... football? – No, I can't.  
 a. go                      b. know                      c. play                      d. stand
3. I'm thirsty. I'd like .....  
 a. a banana              b. a hamburger              c. a packet of milk              d. a bread
4. Can you ride a bike? - .....  
 a. No, I can              b. No, thanks              c. Yes, I can              d. No, I do
5. Can Tom swim ..... play football? – Yes, he can.  
 a. but                      b. end                      c. and                      d. not
6. Can you sing? – Yes, I .....  
 a. can't                      b. can                      c. can's                      d. cans
7. I'd like ..... apple, please.  
 a. a                      b. four                      c. an                      d. and
8. He was born ..... April 10th, 1990.  
 a. at                      b. on                      c. in                      d. from
9. How ..... pens do you have? – I have 2 pens.  
 a. are                      b. many                      c. much                      d. so
10. Choose the odd one out  
 a. father                      b. mother                      c. teacher                      d. sister

**exercise 4: Listen and tick the correct photo. (Nghe và chọn hình đúng).**  
 (Track 16)

	a	b	c	d
1				
2				



3				
4	<b>MONDAY!</b>	Tuesday	Friday	Happy Sunday
5				
6				
7	Happy Saturday	Thursday	Tuesday	Wednesday
8				
9		<b>Math</b>		
10				











# TEST B

**Exercise 1: Reorder the words/ phrases to make complete sentences.** (Sắp xếp lại từ hoặc cụm từ để tạo thành câu hoàn chỉnh).

1. This/ you./ is/ banana/ for  
.....
2. some/ Here/ for my teacher./ flowers/ are  
.....
3. big or/ your/ small?/ Is/ school  
.....
4. am/ from/ I/ England.  
.....
5. Tom/ a/ can/ bicycle./ ride  
.....
6. is/ It/ pencil./ long/ a  
.....
7. you,/ to/ Jenny./ birthday/ Happy  
.....
8. two/ I/ cats./ have  
.....
9. I/ dance./ can/ sing/ and  
.....
10. me/ Please,/ give/ more./ some  
.....

**Exercise 2: Match each picture with a suitable word/ phrase.** (Nối tranh với từ/ cụm từ thích hợp).

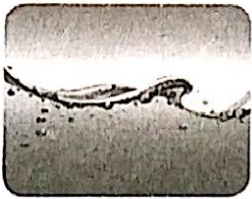
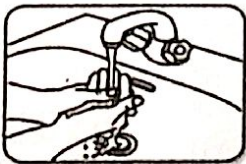
	PICTURE		WORD/ PHRASE
1		a	rainy

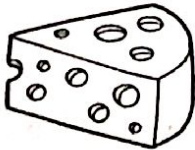
2		b	sink
3		c	tea
4		d	ball
5		e	spoon
6		f	water
7		g	cheese
8		h	glass
9		i	nurse



10		j	flat
----	---	---	------

Your answers















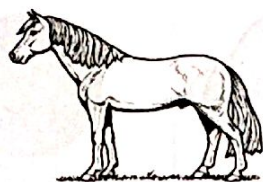



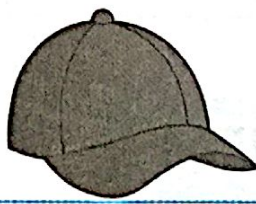

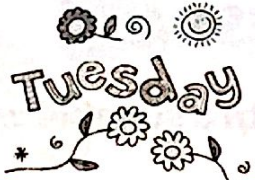

1.	3.	5.	7.	9.
2.	4.	6.	8.	10.



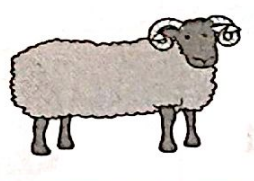
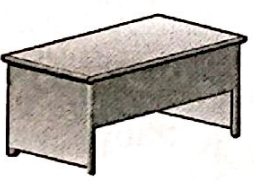





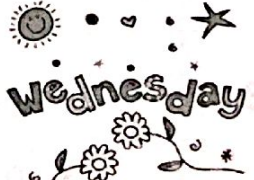

**Exercise 3: Choose the correct answer. (Chọn đáp án đúng).**

1. I have ..... robot.  
a. a                      b. an                      c. two                      d. and
2. Would you like ..... milk? – No, thanks.  
a. a                      b. an                      c. the                      d. some
3. What's ..... name? – He's Tommy.  
a. her                      b. his                      c. she                      d. he
4. What ..... you like? – I'd like an apple.  
a. who                      b. how                      c. would                      d. when
5. Peter can ..... a bike.  
a. ride                      b. play                      c. stay                      d. drink
6. Choose the odd one out  
a. May                      b. July                      c. April                      d. Jimmy
7. This banana is ..... you, Jim.  
a. on                      b. for                      c. in                      d. under
8. Would you ..... to play football now? – No, I can't.  
a. find                      b. bye                      c. hi                      d. like
9. Thank you very much. – You're .....  
a. well                      b. stay                      c. welcome                      d. come
10. .... she have Music today?  
a. Do                      b. Does                      c. Can                      d. Are

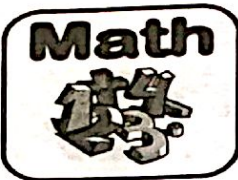

**Exercise 4: Listen and tick the correct photo. (Nghe và chọn hình đúng).**  
(Track 17)



	a	b	c	d
1				
2				
3				
4				
5				
6				
7				







8				
9				
10				

**ROUND 9**

**TEST A**

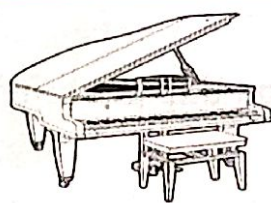
**Exercise 1: Match each picture with a suitable word/ phrase. (Nối tranh với từ/ cụm từ thích hợp).**

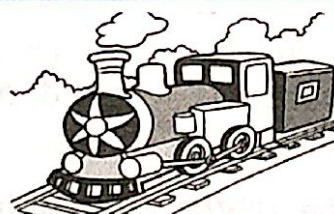
	PICTURE		WORD/ PHRASE
1		a	ride a horse
2		b	baby
3		c	train

4		d	two clouds
5		e	snowman
6		f	teddy bear
7		g	peach
8		h	frog
9		i	piano
10		j	gift

Your answers

1.	3.	5.	7.	9.
2.	4.	6.	8.	10.







**Exercise 2: Put missing letters or a word to complete these sentences.**  
 (Điền chữ cái hoặc từ còn thiếu để hoàn thành câu).







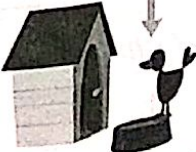

1. That's my father' \_ car.
2. It's su \_ ny in Hue.
3. My books are o \_ the table.
4. Those a \_ \_ our erasers.
5. Peter can speak Vietname \_ \_ .
6. Would you like some \_ i \_ k? – Yes, please.
7. Wou \_ \_ you like an apple?
8. My sister's room is \_ arge.
9. Peter \_ \_ from Americ \_ .
10. I was b \_ \_ n in April.

**Exercise 3: Choose the correct answer.** (Chọn đáp án đúng).

1. .... a round ball.  
 a. Is it                      b. It's                      c. What is                      d. They are
2. Do you want some milk? - .....  
 a. Yes, I do                      b. Yes, I don't                      c. No, I do                      d. Yes, I can
3. Do you like a .....? – Yes, I do.  
 a. biscuit                      b. football                      c. house                      d. this
4. How ..... is she? – She's nine years old.  
 a. oh                      b. and                      c. but                      d. old

**Exercise 4: Listen and tick the correct photo.** (Nghe và chọn hình đúng).  
 (Track 18)





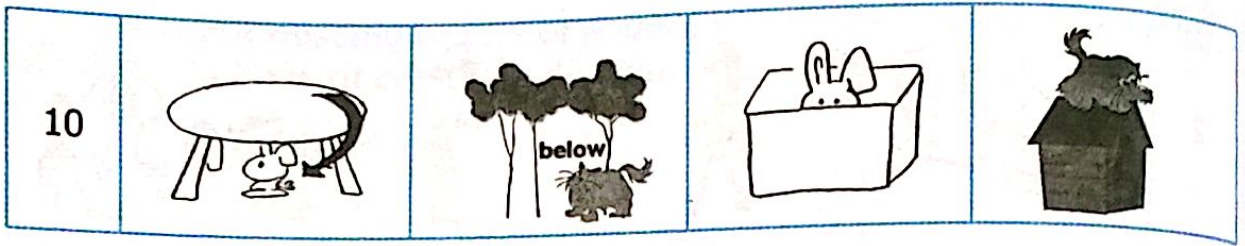

	a	b	c	d
1				





2				
3				
4				
5				
6				
7				
8				
9				



## TEST B

**Exercise 1: Match each picture with a suitable word/ phrase. (Nối tranh với từ/ cụm từ thích hợp).**

	PICTURE		WORD/ PHRASE
1		a	violin
2		b	frog
3		c	spoon
4		d	rice
5		e	orange juice
6		f	curtain

7		g	cassette
8		h	grandfather
9		i	green bed
10		j	engineer

*Your answers*

1.	3.	5.	7.	9.
2.	4.	6.	8.	10.

**Exercise 2: Put missing letters or a word to complete these sentences.**  
 (Điền chữ cái hoặc từ còn thiếu để hoàn thành câu).

















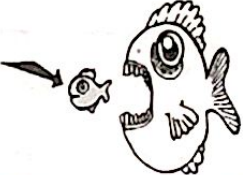

1. \_\_ \_en is your birthday?
2. This flo\_\_ \_r is for you. – Thank you.
3. What's \_\_\_ \_ \_ name? – My name is Tom.
4. Can she p\_\_ \_y football? – No, she can't.
5. Peter \_\_ \_ from America.
6. \_\_\_ \_s is my pencil box.
7. Today I ha\_e Maths and Music.
8. H\_\_ \_'s the weather in Hanoi?
9. Can you sp\_\_ \_k English?
10. This is my m\_ther.













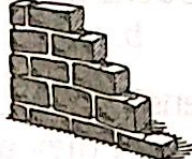







**Exercise 3: Choose the correct answer. (Chọn đáp án đúng).**

1. .... do you live? – I live in Ha Noi.  
 a. How                      b. When                      c. Where                      d. What
2. These ..... red crayons.  
 a. is                              b. am                              c. are                              d. a
3. Where ..... the books? – They are on the table.  
 a. is                              b. are                              c. am                              d. this
4. .... this? – It's a box.  
 a. Is                              b. What                              c. What's                              d. What colour

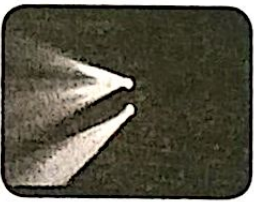
**Exercise 4: Listen and tick the correct photo. (Nghe và chọn hình đúng)**  
 (Track 19)

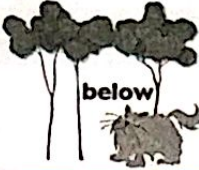
	a	b	c	d
1				
2				
3				
4				
5				

6				
7				
8				
9				
10				

## ROUND 10

### TEST A



**Exercise 1: Choose the correct answer. (Chọn đáp án đúng).**





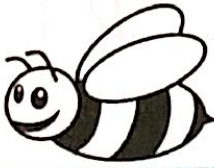

- ..... notebooks are there in your bag? – There are 2 notebooks.  
 a. Where                      b. Can                      c. Do                      d. How many
- Can you sing, Helen? – Yes, I .....  
 a. can't                      b. can's                      c. can                      d. cans
- Tom can ride ..... bike.  
 a. an                      b. these                      c. those                      d. a

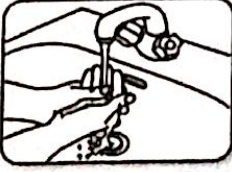

4. How ..... books are there on your shelf? – There are 10 books.  
 a. when                      b. very                      c. many                      d. old
5. Are these your pens? – Yes, .....  
 a. this is                      b. they aren't                      c. there are                      d. they are
6. My books are ..... the table.  
 a. at                      b. to                      c. under                      d. on
7. Where's Alice .....? – She's from England.  
 a. from                      b. come                      c. is                      d. on
8. This gift is for you. - .....  
 a. Thanks you                      b. Thank your                      c. Thank you                      d. Thank
9. .... is your favourite drink? – I like orange juice.  
 a. How                      b. What                      c. When                      d. Who
10. Can you dance, Kate? - ....., I can't.  
 a. No                      b. Not                      c. Yes                      d. Yes I am

**Exercise 2: Match each picture with a suitable word/ phrase. (Nối tranh với từ/ cụm từ thích hợp).**

	PICTURE		WORD/ PHRASE
1		a	bee
2		b	wash hands
3		c	rainy
4		d	sad

5		e	jump
6		f	flag
7		g	pizza
8		h	skip rope
9		i	cassette
10		j	television

Your answers

1.	3.	5.	7.	9.
2.	4.	6.	8.	10.

**Exercise 3: Put missing letters or a word to complete these sentences.**  
 (Điền chữ cái hoặc từ còn thiếu để hoàn thành câu).

1. There \_\_\_ twelve students in my class.
2. VIE\_ NAM
3. I \_\_ a student at Oxford Primary School.
4. I h\_ ve a new pen.







5. The map is on the wa\_\_.
6. My classr\_\_m is so big.
7. \_\_\_ many books are there on the shelf? – There are twelve.
8. Show me y\_\_r pens, children.
9. She is ha\_\_y because today is her birthday.
10. STUDEN\_\_

**Exercise 4: Listen and choose what you hear** (Nghe và chọn phương án em nghe thấy). (Track 20)

1.
  - a. Where are the desks?
  - b. Where are the books?
  - c. Where are the cooks?
  - d. Where are the boxes?
2.
  - a. Yes, she is. But Tommy is stronger.
  - b. Yes, it is. But Tony is stronger.
  - c. Yes, she is. But Tom is stronger.
  - d. Yes, he is. But Tom is stronger.
3.
  - a. Oh, I love Arts.
  - b. Oh, I love Maths.
  - c. Oh, I love Jack.
  - d. Oh, I love that.
4.
  - a. They're on the boards.
  - b. They're on the boxes.
  - c. They're on the books.
  - d. They're on the boats.
5.
  - a. It's a new chalk.
  - b. It's a new fork.
  - c. It's a new clock.
  - d. It's a new fog.
6.
  - a. There are two boxes on the wall.
  - b. There are two boards on the wall.
  - c. There are two boats on the wall.
  - d. There are two clocks on the wall.
7.
  - a. I like English very much.
  - b. I like music very much.
  - c. I like music.
  - d. I really like music.





8. a. Tony is smaller. b. Tony is taller.  
c. Tony is bigger. d. Tony is shorter.
9. a. She's from Australia. b. She's from America.  
c. She's from Canada. d. She's from England.
10. a. Where are the tents? b. Where are the men?  
c. Where are the pencils? d. Where are the pens?







### TEST B



**Exercise 1: Choose the correct answer. (Chọn đáp án đúng).**

1. Can she speak Vietnamese? - .....  
a. Yes, I can't      b. No, I can      c. No, she can't      d. Yes, she do
2. Choose the odd one out.  
a. Tom      b. Mary      c. Alice      d. When
3. Can the ..... fly? – Yes, it can.  
a. dog      b. cat      c. fish      d. bird
4. Where is Tom today? - .....  
a. He's at school      b. He's from America  
c. He's 10 years old      d. He's a student
5. What's ..... name? – She's Mary.  
a. her      b. his      c. this      d. the
6. Choose the odd one out.  
a. Father      b. Mother      c. Teacher      d. Sister
7. Choose the odd one out.  
a. Maths      b. Science      c. Vietnam      d. Arts
8. How ..... pencils are there in the box? – There are 2 pencils.  
a. are      b. many      c. much      d. old
9. Tom lives ..... France.  
a. on      b. in      c. to      d. at
10. What can you do? – I can swim ..... dance.  
a. and      b. or      c. but      d. too

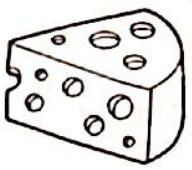

**Exercise 2: Match each picture with a suitable word/ phrase. (Nối tranh với từ/ cụm từ thích hợp).**

	PICTURE		WORD/ PHRASE
1		a	rainy
2		b	run
3		c	family
4		d	sick
5		e	fire
6		f	cheese
7		g	mouth
8		h	cassette

9		i	mirror
10		j	crocodile

Your answers

1.	3.	5.	7.	9.
2.	4.	6.	8.	10.

**Exercise 3: Put missing letters or a word to complete these sentences.**  
(Điền chữ cái hoặc từ còn thiếu để hoàn thành câu).

1. There are three pencil box \_ \_ .
2. These flowers are for you. – Thank you very m \_ \_ h.
3. Tom is ten years o \_ \_ now.
4. These are pi \_ k books.
5. Goodbye. See you l \_ \_ \_ r.
6. MORNIN \_
7. My sister \_ \_ tall.
8. \_ NGLAND
9. There are m \_ \_ \_ flowers in our school.
10. Happy birthday, Hai. This gift is for you. – Thank you \_ \_ \_ y much.

**Exercise 4: Listen and choose what you hear** (Nghe và chọn phương án em nghe thấy). (Track 21)

1.
 

a. I like English very much. c. I like music.	b. I like music very much. d. I really like music.
--	---



2.

- a. Look at Tom and Tony. Who is smaller?
- b. Look at Tom and Tony. Who is bigger?
- c. Look at Tom and Tony. Who is taller?
- d. Look at Tom and Tony. Who is stronger?

3.

- a. We have only four lessons today.
- b. We have only four pupils today.
- c. We have only four actions today.
- d. We have only four sisters today.

4.

- a. It's today.
- b. It's Sunday.
- c. It's Monday.
- d. It's Friday.

5.

- a. We all like music.
- b. We don't like music.
- c. We all like English.
- d. We all like juice.

6.

- a. She is wonderful.
- b. She is pretty.
- c. She is beautiful.
- d. She is intelligent.

7.

- a. Oh, my sister likes driving, too.
- b. Oh, my sister likes writing, too.
- c. Oh, my sister likes riding, too.
- d. Oh, my sister likes drawing, too.

8.

- a. They're in the classroom.
- b. They're in the artroom.
- c. They're in the bathroom.
- d. They're in the bedroom.

9.

- a. How many books are there?
- b. How many pens are there?
- c. How many notebooks are there?
- d. How many notepads are there?

10.

- a. What does she look like?
- b. How does she look like?
- c. What does he look like?
- d. What does he look like?





# ROUND 11

## TEST A

**Exercise 1: Pick out one redundant letter to make the correct word. (Bỏ một chữ cái thừa để có từ đúng).**

1. WALJL
2. MIRROHR
3. EUAT
4. CLASSGROOM
5. SBKY
6. MUSQIC
7. DESJK
8. SINGERR
9. CHDAIR
10. CLOPCK



**Exercise 2: Reorder the words/ phrases to make complete sentences. (Sắp xếp lại từ hoặc cụm từ để tạo thành câu hoàn chỉnh).**

1. There/ pencil boxes./ two/ are  
.....
2. dolls./ has/ two/ Mary  
.....
3. gift/ you./ This/ for/ is  
.....
4. is/ This/ green./ shirt/ a  
.....
5. an/ ice cream?/ Would/ you/ like  
.....
6. very/ English/ I/ much./ like  
.....







7. today./ It's/ hot  
.....



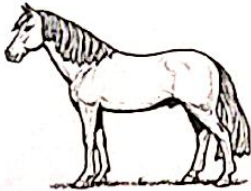

8. Oxford Primary School./ at/ a student/ is/ Mary  
.....

9. dance/ and/ can/ sing./ She  
.....

10. our/ classroom./ is/ This  
.....

**Exercise 3: Match each picture with a suitable word/ phrase.** (Nối tranh với từ/ cụm từ thích hợp).

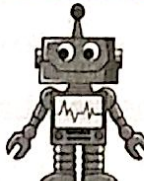
	PICTURE		WORD/ PHRASE
1		a	two televisions
2		b	three pens
3		c	shoes
4		d	horse
5		e	three monkeys

6		f	kangaroo
7		g	snack
8		h	elephant
9		i	robot
10		j	snail

Your answers

1.	3.	5.	7.	9.
2.	4.	6.	8.	10.

**Exercises 4: Listen and choose the correct answer.** (Nghe và chọn đáp án đúng). (Track 22)

1. Every day he gets up at .....
  - a. seven thirty
  - b. six fifteen
  - c. six thirteen
  - d. six thirty
  
2. It's time to go .....
  - a. to bath
  - b. to bed
  - c. to that
  - d. back
  
3. Oh, really? My father's a ....., too
  - a. worker
  - b. factory manager
  - c. manager
  - d. factory worker







4. He watches ..... or listens to music.  
a. a film                      b. TV                      c. story                      d. movie
5. She is ..... years old.  
a. eight                      b. nine                      c. three                      d. nineteen
6. He's a .....  
a. walker                      b. teacher                      c. doctor                      d. worker
7. What time is it .....?  
a. brown                      b. man                      c. now                      d. you
8. How many ..... are there in the classroom?  
a. desks                      b. chairs                      c. books                      d. doors
9. It's time to go for a ....., Tom.  
a. wall                      b. work                      c. walk                      d. watch
10. She ..... in a primary school.  
a. studies                      b. works                      c. lives                      d. teaches

## TEST B

**Exercise 1: Pick out one redundant letter to make the correct word. (Bỏ một chữ cái thừa để có từ đúng).**

1. PICTGURE
2. PIQG
3. QUESTINON
4. FISRH
5. FLOWKER
6. SNUEAKERS
7. RUOLER
8. LISTGEN
9. KIXTCHEN
10. EENGINEER













**Exercise 2: Reorder the words/ phrases to make complete sentences.**  
 (Sắp xếp lại từ hoặc cụm từ để tạo thành câu hoàn chỉnh).

1. My toys/ the/ are/ in/ brown box.  
 .....
2. on the/ My/ books/ are/ bookshelf.  
 .....
3. has/ two/ Mary/ dolls.  
 .....
4. remember/ my birthday?/ you/ Can  
 .....
5. Where/ from/ you/ are/ , Tommy?  
 .....
6. notebooks?/ and/ Where/ are/ the books  
 .....
7. today./ sunny/ weather/ The/ is  
 .....
8. so/ today./ It's/ hot  
 .....
9. play football./ She/ can/ and/ tennis  
 .....
10. old./ years/ She/ is/ ten  
 .....

**Exercise 3: Match each picture with a suitable word/ phrase.** (Nối tranh với từ/ cụm từ thích hợp).

	PICTURE		WORD/ PHRASE
1		a	stove



2		b	television
3		c	sleep
4		d	bee
5		e	three cats
6		f	two dogs
7		g	park
8		h	grape
9		i	three telephones



10		j	hands
----	--	---	-------

Your answers

1.	3.	5.	7.	9.
2.	4.	6.	8.	10.

**Exercises 4: Listen and choose the correct answer.** (Nghe và chọn đáp án đúng). (Track 23)

1. He works in a ..... .  
 a. stadium                      b. post office                      c. hospital                      d. bookshop
2. We're ..... Let's ..... .  
 a. late – jump                      b. late – run                      c. fast – run                      d. late – ring
3. It's time to go ..... .  
 a. to bath                      b. to bed                      c. to that                      d. back
4. He's a ..... worker.  
 a. family                      b. fifty                      c. slim                      d. factory
5. It's time to go for a ..... Tom.  
 a. wall                      b. work                      c. walk                      d. watch
6. What does ..... do?  
 a. your mother                      b. her father                      c. their mother                      d. your father
7. Every day he gets up at ..... .  
 a. seven thirty                      b. six fifteen                      c. six thirteen                      d. six thirty
8. She is ..... years old.  
 a. eight                      b. nine                      c. three                      d. nineteen
9. He watches ..... or listens to music.  
 a. a film                      b. TV                      c. story                      d. movie
10. She ..... in a bookshop.  
 a. studies                      b. works                      c. lives                      d. teaches





# ROUND 12

## TEST A

**Exercise 1: Put missing letters or a word to complete these sentences.** (Điền chữ cái hoặc từ còn thiếu để hoàn thành câu).

1. When is your bi\_\_ \_\_ day? - It's in May.
2. Your bedr\_\_ \_\_ is so big.
3. My books are on the booksh\_\_ \_\_ f.
4. My toys are in that b\_\_ x.

**Exercise 2: Pick out one redundant letter to make the correct word.** (Chọn một chữ cái thừa để có từ đúng).

1. GIFTI
2. SPETAK
3. WAMLL
4. BANWANA
5. ENGLRAND
6. WRINTE
7. WELCOSME
8. HXOT
9. FRIENSD
10. DANLCE

**Exercise 3: Match each picture with a suitable word / phrase.** (Nối tranh với từ / cụm từ thích hợp).

	PICTURE		WORD / PHRASE
1		a	school bag



## ROUND 12

### TEST A

**Exercise 1: Put missing letters or a word to complete these sentences.** (Điền chữ cái hoặc từ còn thiếu để hoàn thành câu).

1. When is your bi\_\_ \_ day? – It's in May.
2. Your bedr\_\_ \_ is so big.
3. My books are on the booksh\_\_ \_ f.
4. My toys are in that b\_x.











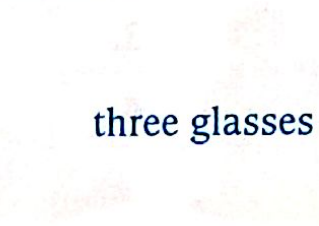

**Exercise 2: Pick out one redundant letter to make the correct word.** (Bỏ một chữ cái thừa để có từ đúng).

1. GIFTI
2. SPETAK
3. WAMLL
4. BANWANA
5. ENGLRAND
6. WRINTE
7. WELCOSME
8. HXOT
9. FRIENSD
10. DANLCE

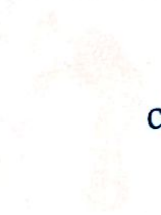
**Exercise 3: Match each picture with a suitable word / phrase.** (Nối tranh với từ/ cụm từ thích hợp).

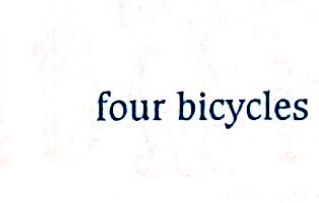
	PICTURE		WORD / PHRASE
1		a	school bag

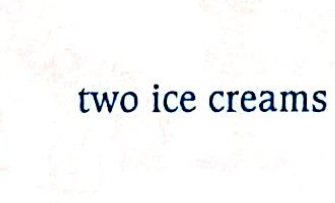

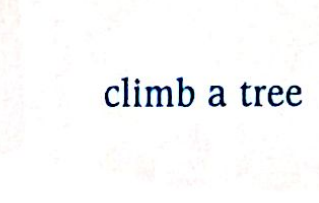
2		b	 gift
3		c	 van
4		d	 three glasses
5		e	 cheese
6		f	 four bicycles
7		g	 two ice creams
8		h	 climb a tree





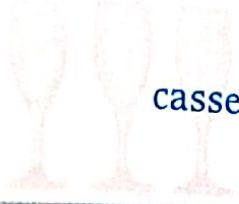
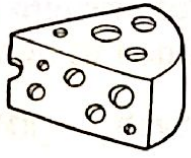
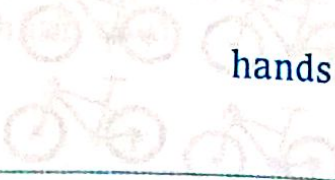



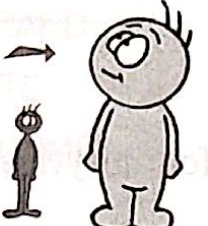
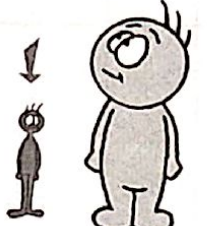

9		i	 cassette
10		j	 hands

Your answers

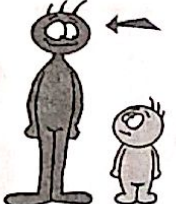
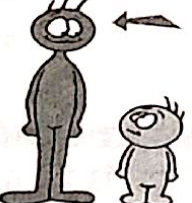
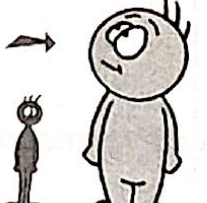
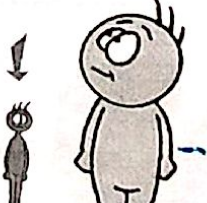
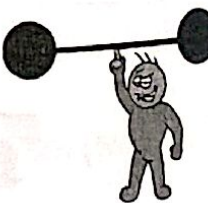
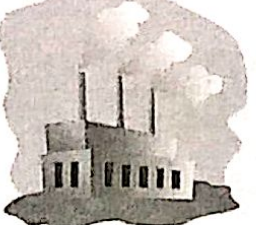
1.	3.	5.	7.	9.
2.	4.	6.	8.	10.

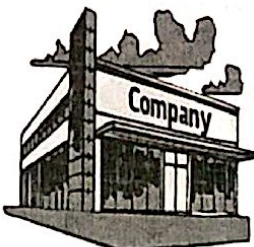
**Exercise 4: Listen and tick the correct photo.** (Nghe và chọn hình đúng).  
(Track 24)

	a	b	c	d
1				
2				
3				



4				
5				
6				
7				
8				
9				
10				



# TEST B

**Exercise 1: Put missing letters or a word to complete these sentences.**  
(Điền chữ cái hoặc từ còn thiếu để hoàn thành câu).





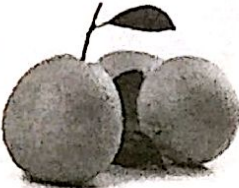

1. Tom can s \_ \_ \_ k Vietnamese.
2. Is your classr \_ \_ m big? – Yes, it is.
3. Do you h \_ \_ e Maths today?
4. These are my pens. They \_ \_ \_ on the desk.

**Exercise 2: Pick out one redundant letter to make the correct word.** (Bỏ một chữ cái thừa để có từ đúng).

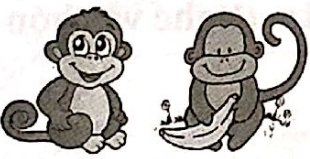

1. SOKNG
2. ROBOLT
3. STUDEKNT
4. TABCLE
5. KITCHXEN
6. NATME
7. APPLVE
8. NUMBWER
9. SNOYWY
10. CHAEIR

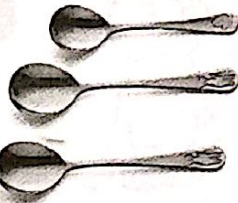
**Exercise 3: Match each picture with a suitable word/ phrase.** (Nối tranh với từ/ cụm từ thích hợp).

	PICTURE		WORD/ PHRASE
1		a	biscuits

2		b	three spoons
3		c	three oranges
4		d	two cows
5		e	car
6		f	three robots
7		g	house
8		h	sunglasses

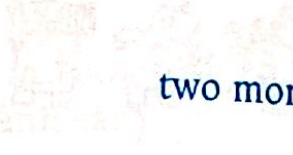

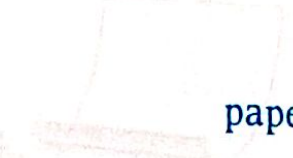







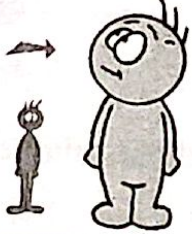
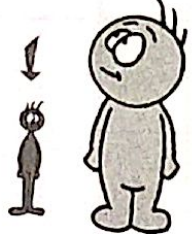
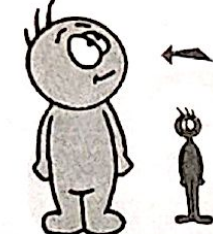

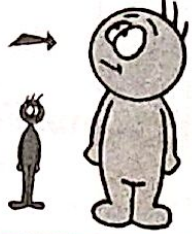
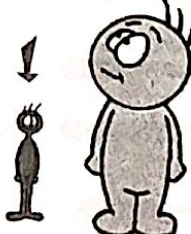















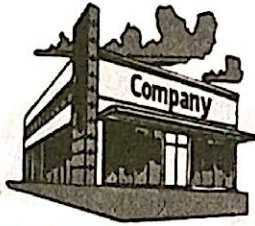



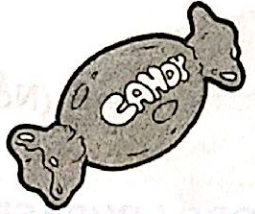

9		i		two monkeys
10		j		paper

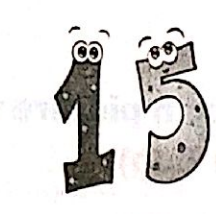
Your answers

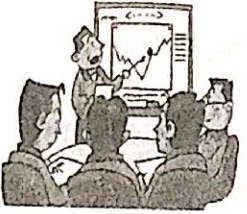
1.	3.	5.	7.	9.
2.	4.	6.	8.	10.

**Exercise 4: Listen and tick the correct photo. (Nghe và chọn hình đúng)**

	a	b	c	d
1				
2				
3				

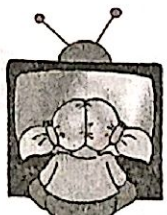
4				
5				
6				
7				
8				
9				
10				





# ROUND 13







## TEST A

**Exercise 1: Put missing letters or a word to complete these sentences.** (Điền chữ cái hoặc từ còn thiếu để hoàn thành câu).

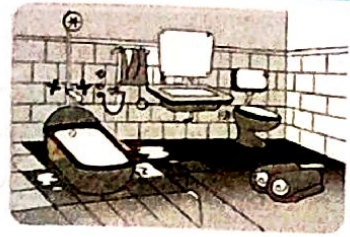
1. Can you swim? - \_\_\_, I can't.
2. C\_\_cle the answer, please.
3. There are s\_\_\_n days in a week.
4. She is my fr\_\_\_d, too.
5. My favourite sub\_\_\_t is Music.
6. Would you like some or\_\_\_ge juice?
7. Bye. See you tomo\_\_\_ow.
8. Mary is at sch\_\_\_l.
9. C\_\_cle the answer, please.
10. This is a r\_\_\_it.

**Exercise 2: Match each picture with a suitable word/ phrase.** (Nối tranh với từ/ cụm từ thích hợp).

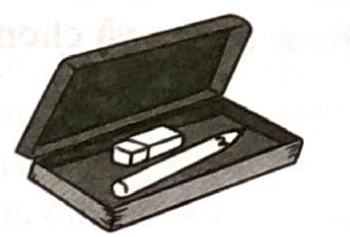
	PICTURE		WORD/ PHRASE
1		a	kitchen
2		b	pencil box

3		c	bottle
4		d	fourteen
5		e	bathroom
6		f	bee
7		g	four monkeys
8		h	drink
9		i	climb a tree



10		j	hat
----	--	---	-----

Your answers

1.	3.	5.	7.	9.
2.	4.	6.	8.	10.

**Exercise 3: Choose the correct answer. (Chọn đáp án đúng).**

- Can the cat fly? - .....  
 a. No, it can      b. No, it does      c. No, it can't      d. No, it doesn't
- ..... your friend's name?  
 a. What's      b. How's      c. When's      d. Who's
- ..... students are there in your class? – There are eleven students.  
 a. How many      b. How much      c. How old      d. What
- ..... are they? – They're my friends.  
 a. Who      b. What      c. Which      d. Where

**Exercise 4: Listen and choose what you hear (Nghe và chọn phương án em nghe thấy). (Track 26)**

- Farmers work five days a week.
  - Workers work five days a week.
  - Doctors work five days a week.
  - Drivers work five days a week.
- Where does she work?
  - When does he work?
  - Where does he work?
  - Who does he work for?
- She often plays tennis at 4:30 p.m.
  - She often plays table tennis at 4:00 p.m.
  - She often plays table tennis at 4:30 p.m.
  - She often plays table tennis at 2:30 p.m.





4.
  - a. Everyday I get up at six o'clock.
  - b. Everyday I get up at seven o'clock.
  - c. Everyday I get up at six thirteen o'clock.
  - d. Everyday I get up at five o'clock.
5.
  - a. On Monday he usually takes my family to my grandparents'.
  - b. On Saturday he usually takes my family to my grandparents'.
  - c. On Sunday he usually takes my family to my grandparents'.
  - d. On Friday he usually takes my family to my grandparents'.
6.
  - a. My father works for a boat company.
  - b. My father works for a big company.
  - c. My father works for a board company.
  - d. My father works for a bus company.
7.
  - a. My brother is a bus driver in London.
  - b. My brother is a taxi-driver in London.
  - c. My brother is a driver in London.
  - d. My brother is a truck driver in London.
8.
  - a. He has dinner with family at six thirteen.
  - b. He has dinner with family at six fifteen.
  - c. He has dinner with family at six thirty.
  - d. He has dinner with family at six fifty.
9.
  - a. When do you go for a bath?
  - b. When do you go to the board?
  - c. When do you go for lunch?
  - d. When do you go to bed?
10.
  - a. Tony and Jane go to school at six.
  - b. Tony and Jane go to school seven ten.
  - c. Tony and Jane go to school at seven.
  - d. Tony and Jane go to school at seven fifteen.











# TEST B

**Exercise 1: Put missing letters or a word to complete these sentences.**  
(Điền chữ cái hoặc từ còn thiếu để hoàn thành câu).

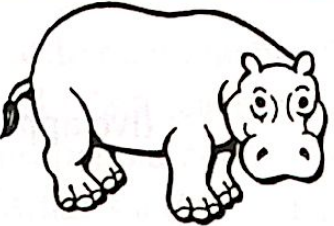
1. Can you s\_im, Tom? – No, I can't.
2. What is her j\_\_? – She is a teacher.
3. My books are \_\_ the bookshelf.
4. My books are on the ta\_\_e.
5. This is my sister. \_\_\_ name is Alice.
6. That's my fa\_\_er.
7. Do you have toys? – Yes, I h\_\_\_ a doll.
8. Would you like some or\_\_ge juice?
9. H\_\_ is the weather today? – It's cool today.
10. CH\_\_KEN.

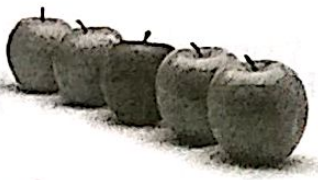
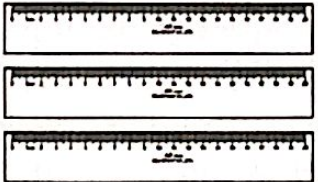
**Exercise 2: Match each picture with a suitable word/ phrase.** (Nối tranh với từ/ cụm từ thích hợp).

	PICTURE		WORD/ PHRASE
1		a	fourteen
2		b	penguin

3		c	red beds
4		d	hippo
5		e	numbers
6		f	three rulers
7		g	listen to music
8		h	hands
9		i	four bears





10		j	
----	--	---	--

Your answers

1.	3.	5.	7.	9.
2.	4.	6.	8.	10.

**Exercise 3: Choose the correct answer. (Chọn đáp án đúng).**

1. .... do you like? – I like pizza.  
 a. Where                      b. What                      c. How                      d. Who
2. How ..... robots are there?  
 a. many                      b. much                      c. any                      d. very
3. .... do you like? – I like milk.  
 a. How                      b. What                      c. When                      d. Who
4. .... students are there in your class? – There are eleven students.  
 a. How many                      b. How much                      c. How old                      d. What

**Exercise 4: Listen and choose what you hear (Nghe và chọn phương án em nghe thấy). (Track 27)**

1.
 

a. What does your brother do?	b. What does your father do?
c. What does your sister do?	d. What does your mother do?
2.
 

a. She leaves for breakfast at seven.	b. She leaves for school at seven.
c. She leaves for work at seven.	d. She leaves for a walk at seven.
3.
 

a. The doctor is sitting on a chair.	b. The doctor is standing on a chair.
c. The doctor is reading on a chair.	d. The doctor is lying on a chair.



4.
  - a. My mother's a teacher. She teaches at school.
  - b. My father's a teacher. She teaches at school.
  - c. My mother's a doctor. She works in a hospital.
  - d. My father's a doctor. He works in a hospital.
5.
  - a. Farmers work five days a week.
  - b. Workers work five days a week.
  - c. Doctors work five days a week.
  - d. Drivers work five days a week.
6.
  - a. Where does she work?
  - b. When does he work?
  - c. Where does he work?
  - d. What does he work for?
7.
  - a. She often plays tennis at 4:30 p.m.
  - b. She often plays table tennis at 4:00 p.m.
  - c. She often plays table tennis at 4:30 p.m.
  - d. She often plays table tennis at 2:30 p.m.
8.
  - a. Everyday I get up at six o'clock.
  - b. Everyday I get up at seven o'clock.
  - c. Everyday I get up at six thirteen o'clock.
  - d. Everyday I get up at five o'clock.
9.
  - a. On Monday he usually takes my family to my grandparents'.
  - b. On Saturday he usually takes my family to my grandparents'.
  - c. On Sunday he usually takes my family to my grandparents'.
  - d. On Friday he usually takes my family to my grandparents'.
10.
  - a. My father works for a boat company.
  - b. My father works for a big company.
  - c. My father works for a board company.
  - d. My father works for a bus company.



# ROUND 14

## TEST A

**Exercise 1: Reorder the words/ phrases to make complete sentences.**  
(Sắp xếp lại từ hoặc cụm từ để tạo thành câu hoàn chỉnh).

1. Take/ children./ out/ your/ pencils,  
.....
2. some/ orange/ Do you/ juice?/ like  
.....
3. ride/ can/ My/ sister/ a bike.  
.....
4. flowers/ Here/ for you./ some/ are  
.....
5. I/ have/ two/ dolls.  
.....
6. in/ are there/ your classroom?/ How/ many students  
.....
7. room,/ Clean/ Peter./ your  
.....
8. Music lessons?/ do/ What/ you do/ during  
.....
9. bedroom/ is/ My/ small./ very  
.....
10. is/ at/ Jack/ a student/ London Primary School.  
.....



**Exercise 2: Choose the correct answer.** (Chọn đáp án đúng).

1. My name's Mary. .... M-A-R-Y.  
a. What's                      b. That's                      c. He's                      d. She's
2. The pictures are ..... the wall.  
a. on                              b. in                              c. to                              d. under
3. Choose the odd one out  
a. Read                              b. Write                              c. Day                              d. Look







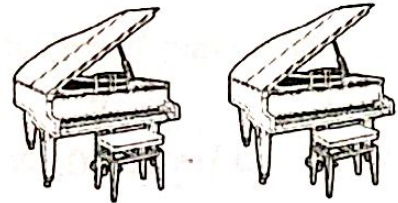

4. Would you like some milk? – No, .....  
 a. thank                      b. thank's                      c. thanks you                      d. thanks
5. .... students are there in your class?  
 a. How many                      b. How much                      c. How old                      d. What
6. Do you like orange juice? – Yes, I .....  
 a. Am                      b. Is                      c. Do                      d. Like
7. Can the bird fly? - .....  
 a. Yes, it can't                      b. Yes, it does                      c. Yes, it can                      d. Yes, it doesn't
8. The maps are ..... the wall.  
 a. under                      b. on                      c. in                      d. for
9. What subject do you like the most? - .....  
 a. Today I have English and Music  
 b. I like Maths the most  
 c. I don't like Music because I can't sing  
 d. Yes, I like it very much.
10. Choose the odd one out  
 a. America                      b. English                      c. Canada                      d. Vietnam

**Exercise 3: Match each picture with a suitable word/ phrase. (Nối tranh với từ/ cụm từ thích hợp).**

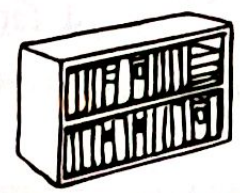
	PICTURE		WORD/ PHRASE
1		a	four penguins
2		b	four crayons
3		c	three cows

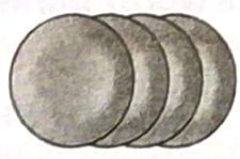

4		d	bottle
5		e	two pizzas
6		f	two pianos
7		g	bookshelf
8		h	three monkeys
9		i	four plates
10		j	train

Your answers

1.	3.	5.	7.	9.
2.	4.	6.	8.	10.





**Exercises 4: Listen and choose the correct answer. (Nghe và chọn đáp án đúng). (Track 28)**

1. This is a ..... of my family.  
a. photo                      b. picture                      c. program                      d. radio
2. I know all the ..... in Hanoi.  
a. trees                      b. fishes                      c. streets                      d. leaves
3. The work finishes at .....  
a. four fifty                      b. four fifteen                      c. five fifty                      d. five fifteen
4. He works for a big .....  
a. company                      b. family                      c. farm                      d. factory
5. Lisa has dinner with .....  
a. her company                      b. her father                      c. her family                      d. her farmer
6. We ..... like hamburgers.  
a. don't                      b. all                      c. do                      d. very
7. They're both drivers in .....  
a. the small company                      b. Jame's company  
c. the same company                      d. the son's company
8. What does he do after .....?  
a. work                      b. lunch                      c. dinner                      d. school
9. My ..... is a housewife.  
a. grandfather                      b. father                      c. mother                      d. grandmother
10. He is ..... mineral water.  
a. drinking                      b. buying                      c. eating                      d. driving

**TEST B**

**Exercise 1: Reorder the words/ phrases to make complete sentences. (Sắp xếp lại từ hoặc cụm từ để tạo thành câu hoàn chỉnh).**

1. want/ stay/ I/ at home./ to  
.....
2. with/ My sister/ play/ a yo yo./ can  
.....
3. Music/ Wednesday./ on/ have/ We don't  
.....





4. to/ you./ nice/ It's/ see  
.....
5. many pens/ I have/ my/ in/ school bag.  
.....
6. like/ the/ today?/ What's/ weather  
.....
7. orange/ Do you/ some/ like/ juice?  
.....
8. chicken./ don't/ I/ like  
.....
9. My/ sing./ and/ sister/ can dance  
.....
10. Maths/ subject./ my/ favourite/ is  
.....

**Exercise 2: Choose the correct answer. (Chọn đáp án đúng).**





1. .... are they? – They're my friends.  
a. Who                      b. What                      c. Which                      d. Where
2. Choose the odd one out  
a. Cake                      b. Pizza                      c. Cheese                      d. Bottle
3. Are these your pens? – No, .....  
a. they aren't              b. it isn't                      c. I'm not                      d. I don't
4. What colour is this? - .....  
a. There are two              b. No, it is                      c. It's pink                      d. Yes, they are
5. Can David speak Vietnamese? - .....  
a. Yes, I can't              b. No, I can                      c. No, he can't              d. Yes, he do
6. What is your favourite .....? – I like pink.  
a. food                      b. drink                      c. subject                      d. colour
7. I ..... Monday and Wednesday because I have Maths lessons then.  
a. fun                      b. bye                      c. like                      d. buy
8. Choose the odd one out.  
a. Mother                      b. Father                      c. You                      d. Sister







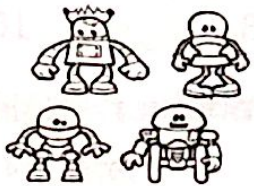

9. Hi, ..... are you from? – I'm from Canada.  
 a. who                      b. how                      c. where                      d. when
10. Is that a pencil? – No, .....  
 a. it isn't                      b. it is                      c. it does                      d. it doesn't

**Exercise 3: Match each picture with a suitable word/ phrase. (Nối tranh với từ/ cụm từ thích hợp).**

	PICTURE		WORD/ PHRASE
1		a	four robots
2		b	snow
3		c	hungry
4		d	sunglasses
5		e	four spiders
6		f	grandmother





7		g	grandfather
8		h	three motorbikes
9		i	five rabbits
10		j	santa Claus

Your answers

1.	3.	5.	7.	9.
2.	4.	6.	8.	10.

**Exercises 4: Listen and choose the correct answer.** (Nghe và chọn đáp án đúng). (Track 29)

- He gets home at ..... in the afternoon.  
 a. five fifteen      b. five thirty      c. five thirteen      d. five fifty
- John's father is a ..... in Sydney.  
 a. teacher      b. farmer      c. doctor      d. worker
- You are ..... and friendly too.  
 a. tiny      b. lovely      c. tidy      d. please
- I go to school ..... a week.  
 a. four days      b. five days      c. six days      d. nine days



5. My father is a ....., too.  
a. truck driver      b. bus driver      c. big driver      d. boat driver
6. She loves her ..... and her work.  
a. pencils      b. children      c. pupils      d. students
7. I live with my family in .....  
a. Bolton      b. Sydney      c. Moscow      d. London
8. Lisa has dinner with .....  
a. her company      b. her father      c. her family      d. her farmer
9. We ..... like hamburgers.  
a. don't      b. all      c. do      d. very
10. They're both drivers in .....  
a. The small company      b. Jame's company  
c. The same company      d. The son's company

## ROUND 15

### TEST A

**Exercise 1: Put missing letters or a word to complete these sentences.**  
(Điền chữ cái hoặc từ còn thiếu để hoàn thành câu).

1. There are twenty stude\_\_ \_ in my class.
2. This gift is for you. – Thank you very m\_\_ \_h.
3. I'm so\_\_ \_y. I'm late.
4. He is a stu\_\_ \_t at Saint Jose Primary School.
5. I like Maths. – When do you h\_\_ \_e it?
6. Do you like pets? - \_\_ \_\_\_, I do.
7. Is this \_\_ \_\_r book? – Yes, it is.
8. Give me a packet \_\_ \_ milk, please.
9. I learn ab\_\_ \_t numbers during Maths lessons.
10. These are three pencils box\_\_ \_ in my school bag.













**Exercise 2: Choose the correct answer. (Chọn đáp án đúng).**

1. They are going ..... school.  
 a. at                                      b. on                                      c. to                                      d. in
2. What ..... her name? – Her name is Elly.  
 a. is                                      b. are                                      c. be                                      d. am
3. What is ..... name? – She is Alice.  
 a. she                                      b. he                                      c. her                                      d. his
4. .... are you? – I'm fine, thank you. And you?  
 a. How old                                      b. How's                                      c. How                                      d. When

**Exercise 3: Match each picture with a suitable word/ phrase. (Nối tranh với từ/ cụm từ thích hợp).**

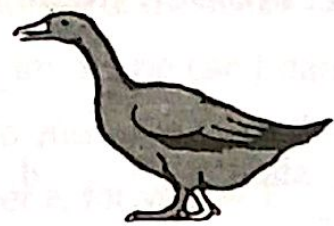
	PICTURE		WORD/ PHRASE
1		a	dance
2		b	music
3		c	three birds
4		d	duck

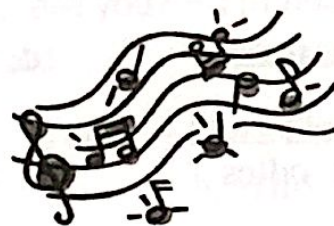

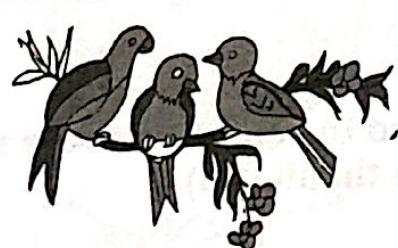
5		e	three babies
6		f	school bus
7		g	snack
8		h	towels
9		i	play table tennis
10		j	spoon

Your answers

1.	3.	5.	7.	9.
2.	4.	6.	8.	10.





**Exercises 4: Listen and choose the correct answer. (Nghe và chọn đáp án đúng). (Track 30)**

- 1. What ..... you like to drink?  
a. could                      b. would                      c. should                      d. do
- 2. This is my .....  
a. new cap                      b. new scarf                      c. silk carf                      d. silk cap
- 3. Coke is ..... favourite drink.  
a. her                      b. his                      c. my                      d. the
- 4. I like beef and .....  
a. duck                      b. ham                      c. chicken                      d. pork
- 5. That's my .....  
a. goldfish                      b. gold dish                      c. gold teeth                      d. own a fish
- 6. Does Jonny like ..... very much?  
a. meat                      b. fish                      c. beef                      d. leaf
- 7. I'd like to ..... chicken.  
a. meet                      b. sit                      c. teach                      d. eat
- 8. I'd like to drink .....  
a. lemonade                      b. water                      c. odles                      d. coffee
- 9. Linda likes bread with .....  
a. cheese                      b. meat                      c. beef                      d. milk
- 10. Would you like some .....?  
a. coffee                      b. apples                      c. noodles                      d. candles

**TEST B**

**Exercise 1: Put missing letters or a word to complete these sentences. (Điền chữ cái hoặc từ còn thiếu để hoàn thành câu).**

- 1. Nice to \_\_\_\_ you, too.
- 2. H\_\_y birthday to you. – Thank you.
- 3. \_\_\_\_t subjects do you have today? – I have Maths today.







4. Would you like som\_ milk?
5. He can s\_im but he can't dance.
6. W\_\_\_ do you have Maths? – I have it on Monday.
7. This flower is for you. – T\_\_\_k you very much.
8. My b\_droom is small.
9. It's su\_ny in Hue.
10. My sister is nine \_\_\_\_\_s old.



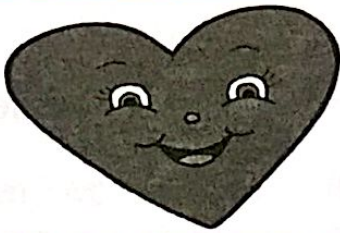

**Exercise 2: Choose the correct answer. (Chọn đáp án đúng).**

1. I have ..... robot.  
 a. a                      b. an                      c. two                      d. and
2. Thank you very much. – You ..... welcome.  
 a. is                      b. am                      c. are                      d. aren't
3. .... are you? – I'm fine, thank you. And you?  
 a. How old              b. How's                      c. How                      d. When
4. .... is she? – She's Elizabeth. She is my sister.  
 a. How                      b. Who                      c. What                      d. Where

**Exercise 3: Match each picture with a suitable word/ phrase. (Nối tranh với từ/ cụm từ thích hợp).**

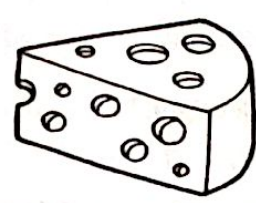
	PICTURE		WORD/ PHRASE
1		a	candle
2		b	pig

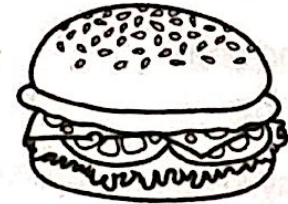

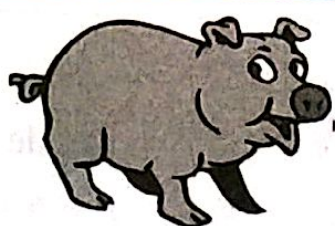
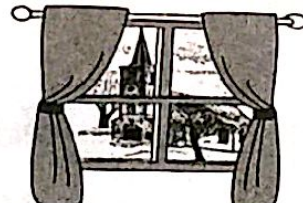
3		c	noisy
4		d	hamburger
5		e	window
6		f	heart
7		g	bed
8		h	bookshelf
9		i	smile



10		j	cheese
----	---	---	--------

Your answers

1.	3.	5.	7.	9.
2.	4.	6.	8.	10.

**Exercises 4: Listen and choose the correct answer.** (Nghe và chọn đáp án đúng). (Track 31)

1. I am .....  
 a. thirteen      b. thirty      c. thirsty      d. ready
2. Does Jonny like ..... very much?  
 a. meat      b. fish      c. beef      d. leaf
3. The ..... is on the .....  
 a. dish – fish      b. teeth – fish      c. fish – dish      d. fish – teeth
4. What's your favourite .....?  
 a. book      b. cook      c. soup      d. food
5. I don't like .....  
 a. orange fruit      b. orange      c. orange juice      d. orange food
6. What's your favourite .....?  
 a. spring      b. bring      c. think      d. drink
7. I'd like to ..... chicken.  
 a. meet      b. sit      c. teach      d. eat
8. The children love ..... It's their favourite drink.  
 a. silk      b. news      c. milk      d. water
9. What ..... you like to drink?  
 a. could      b. would      c. should      d. do
10. This is my .....  
 a. new cap      b. new scarf      c. silk carf      d. silk cap





## ROUND 16

### TEST A

**Exercise 1: Choose the correct answer. (Chọn đáp án đúng).**

1. Would you like a cake? – Yes, .....  
a. please                      b. bye                      c. sorry                      d. here you are
2. Friday is my favourite .....  
a. day's                      b. days                      c. day                      d. a day
3. .... is she happy? – Because today is her birthday.  
a. Why                      b. How                      c. Do                      d. Does
4. There are ..... chairs in my room.  
a. four                      b. a                      c. an                      d. one

**Exercise 2: Put missing letters or a word to complete these sentences. (Điền chữ cái hoặc từ còn thiếu để hoàn thành câu).**

1. Jim can speak Eng\_\_ \_\_h but I cannot speak Vietnamese.
2. I have a cat \_\_ \_\_d a dog.
3. My brother has t\_n pets.
4. Look at the board and w\_\_ \_\_te what the teacher says.
5. I learn a lot ab\_\_ \_\_t animals and plants.
6. Is it a r\_\_ \_\_nd box? – No, it is a square box.
7. This is her n\_\_ \_\_w school. It's big.
8. Do you have any toy\_\_ \_\_?
9. How many pets a\_\_ \_\_ there?
10. This gift is \_\_ \_\_ \_\_ you. – Thank you.







**Exercise 3: Match each picture with a suitable word/ phrase. (Nối tranh với từ/ cụm từ thích hợp).**

	PICTURE		WORD/ PHRASE
1		a	motorbike
2		b	three books
3		c	four rabbits
4		d	numbers
5		e	two teddy bears
6		f	paper
7		g	mirror

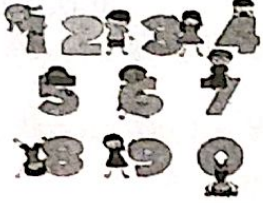

8		h	star
9		i	zero
10		j	key

Your answers

1.	3.	5.	7.	9.
2.	4.	6.	8.	10.

**Exercise 4: Listen and choose what you hear** (Nghe và chọn phương án em nghe thấy). (Track 32)

1.
  - a. She has apples and milk for her breakfast.
  - b. She has noodles and tea for her breakfast.
  - c. She has noodles and milk for her breakfast.
  - d. She has apples and tea for her breakfast.
  
2.
  - a. Here favourite drink is coffee.
  - b. Her favourite drink is milk.
  - c. Her favourite drink is water.
  - d. Her favourite drink is mineral water.



- 3.
- a. I'd like to get chicken.
  - b. I'd like to cook chicken.
  - c. I'd like to eat chicken.
  - d. I don't like to eat chicken.

- 4.
- a. Put the words into the right columns.
  - b. Put the words into the five columns.
  - c. Put the words into the nine columns.
  - d. Put the words into the fine columns.

- 5.
- a. My favourite drink is fruit juice.
  - b. My favourite drink is apple juice.
  - c. My favourite drink is orange juice.
  - d. My favourite drink is lemon juice.

- 6.
- a. I do like orange juice.
  - b. I don't like apple juice.
  - c. I don't love lemon juice.
  - d. I don't like orange juice.

- 7.
- a. Beef and chicken are my favourite foods.
  - b. Fish and chicken are my favourite foods.
  - c. Pork and chicken are my favourite foods.
  - d. Food and chicken are my favourite foods.

- 8.
- a. These are her favourite food and drink.
  - b. These are his favourite food and drink.
  - c. These are my family's favourite food and drink.
  - d. These are my favourite food and drink.



9.

- a. What about some juice?
- b. What about some lemon juice?
- c. What about some apple juice?
- d. What about some orange juice?

10.

- a. It's nice favourite drink.
- b. It's fine favourite drink.
- c. It's my favourite drink.
- d. It's her favourite drink.

## TEST B

### Exercise 1: Choose the correct answer. (Chọn đáp án đúng).

1. Do you have ..... on Friday? No, I have English.  
a. Informatics      b. cakes      c. desks      d. books
2. Where is Tom from? – He is from .....  
a. English      b. England      c. American      d. Singaporean
3. The maps are ..... the wall.  
a. on      b. in      c. between      d. to
4. Would you like ..... ice cream? – Yes, please.  
a. a      b. an      c. some      d. the

### Exercise 2: Put missing letters or a word to complete these sentences. (Điền chữ cái hoặc từ còn thiếu để hoàn thành câu).

1. Hi, Peter. I'm f\_\_m Singapore.
2. My brother is th\_\_e years old.
3. Peter can r\_\_\_ a bike.
4. \_\_w many desks are there? – There are ten desks.
5. It's win\_\_ in Hanoi.









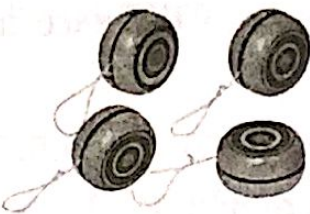

6. How \_ \_ d is your sister?
7. Is your classroom big? - \_ \_ \_ , it is.
8. That is \_ bicycle.
9. My favourite f \_ \_ d is pizza.
10. Hello, Mary. I'm \_ \_ \_ \_ Ho Chi Minh City.

**Exercise 3: Match each picture with a suitable word/ phrase. (Nối tranh với từ/ cụm từ thích hợp).**

	PICTURE		WORD/ PHRASE
1		a	swim
2		b	four frogs
3		c	four bowls
4		d	cars
5		e	four yo-yos



6		f	doll
7		g	skate board
8		h	three ice creams
9		i	three computers
10		j	singer

Your answers

1.	3.	5.	7.	9.
2.	4.	6.	8.	10.

**Exercise 4: Listen and choose what you hear** (Nghe và chọn phương án em nghe thấy). (Track 33)

1.
  - a. Would you like some apples or bread?
  - b. Would you like some noodles or bread?
  - c. Would you like some noodles or beef?
  - d. Would you like some noodles or meat?



2. a. I love milk. I drink it every Monday.  
b. I love milk. I drink it everytime.  
c. I love milk. I drink it everywhere.  
d. I love milk. I drink it everyday.
3. a. What's your favourite food?      b. What's your favourite foot?  
c. What's your favourite cook?      d. What's your favourite book?
4. a. Yes, I like it very much.      b. Yes, I do like it very much.  
c. Yes, I like it much.      d. Yes, I like it.
5. a. What should you like to eat?      b. What would you like to eat?  
c. What could you like to eat?      d. What would you like to drink?
6. a. Is his favourite thing fish?      b. Is this your favourite food?  
c. Is his favourite food chicken?      d. Is his favourite food fish?
7. a. Does Peter like coffee?      b. Does Peter like tea?  
c. Does Peter like milk?      d. Does Peter like beer?
8. a. I love milk.      b. I love silk.      c. I love news.      d. I love chew.
9. a. These are her favourite food and drink.  
b. These are his favourite food and drink.  
c. These are my family's favourite food and drink.  
d. These are my favourite food and drink.
10. a. What about some juice?      b. What about some lemon juice?  
c. What about some apple juice?      d. What about some orange juice?







# ROUND 17





## TEST A

**Exercise 1: Pick out one redundant letter to make the correct word.** (Bỏ một chữ cái thừa để có từ đúng).

1. APPWLE
2. MIALK
3. MAFRCH
4. WHUAT
5. BROBWN
6. OPDEN
7. SCKY
8. WHQEN
9. CHANIR
10. THAHNK

**Exercise 2: Match each picture with a suitable word/ phrase.** (Nối tranh với từ/ cụm từ thích hợp).

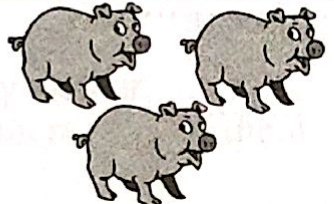
	PICTURE		WORD/ PHRASE
1		a	flower
2		b	tomato
3		c	three fish

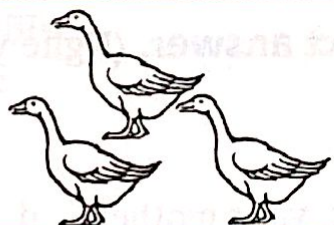
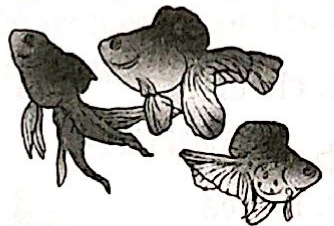
4		d	three pigs
5		e	balloon
6		f	three ducks
7		g	ball
8		h	bed
9		i	three circles
10		j	school bag

Your answers

1.	3.	5.	7.	9.
2.	4.	6.	8.	10.





**Exercise 3: Put missing letters or a word to complete these sentences.**  
(Điền chữ cái hoặc từ còn thiếu để hoàn thành câu).

1. you/ Can/ fly/ a/ kite?  
.....
2. It/ Monday/ today./ is  
.....
3. many/ How/ there?/ are/ rulers  
.....
4. are there/ How many/ that box?/ toys/ in  
.....
5. like/ a/ banana./ I/ would  
.....
6. on/ Monday./ I/ English lessons/ have  
.....
7. in/ twenty/ There are/ students/ my class.  
.....
8. subject/ favourite/ Music./ is/ Her  
.....
9. fly/ can/ I/ kite./ a  
.....
10. there?/ are/ crayons/ How/ many  
.....

**Exercises 4: Listen and choose the correct answer.** (Nghe và chọn đáp án đúng). (Track 34)

1. What does ..... look like?  
a. your sister      b. your teacher      c. your mother      d. your doctor
2. What's she like? – She's .....  
a. joyful      b. beautiful      c. cheerful      d. careful
3. My dad and mum like ..... very much.  
a. beef      b. fish      c. fishes      d. meat
4. I never forgot my ..... days.  
a. neighborhood      b. childhood  
c. robinhood      d. brotherhood





5. Tom's mother is kind and .....  
 a. cheerful                      b. careful                      c. beautiful                      d. wonderful
6. The children are .....  
 a. lovely                      b. lucky                      c. pretty                      d. friendly
7. This is my mother. She isn't .....  
 a. slim                      b. small                      c. short                      d. sporty
8. Is your mother very .....?  
 a. friendly                      b. kindly                      c. lovely                      d. skinny
9. Her mother looks .....  
 a. lucky                      b. pretty                      c. sporty                      d. ready
10. That's my mother .....  
 a. over there                      b. there                      c. here                      d. very nice





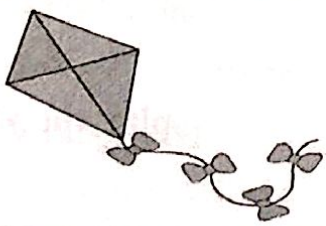

### TEST B

**Exercise 1: Pick out one redundant letter to make the correct word. (Bỏ một chữ cái thừa để có từ đúng).**

1. BEDROVOM
2. ROBWOT
3. ANSWGER
4. WHQEN
5. TABQLE
6. DOLLE
7. MOTRORBIKE
8. CANVDLE
9. CANSDY
10. CAZKE

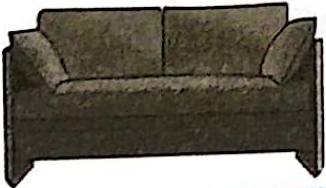
**Exercise 2: Match each picture with a suitable word/ phrase. (Nối tranh với từ/ cụm từ thích hợp).**

	PICTURE		WORD/ PHRASE
1		a	butterfly

2		b	shirt
3		c	cake
4		d	two spoons
5		e	ball
6		f	sofa
7		g	two spiders
8		h	kite
9		i	play the violin

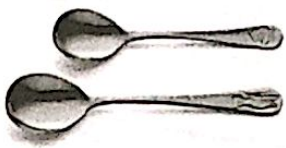

10		j	bicycle
----	---	---	---------

Your answers

1.	3.	5.	7.	9.
2.	4.	6.	8.	10.

**Exercise 3: Reorder the words/ phrases to make complete sentences.**  
 (Sắp xếp lại từ hoặc cụm từ để tạo thành câu hoàn chỉnh).

1. are/ notebooks./ my/ new/ These  
 .....
2. says./ Listen/ the teacher/ what/ to  
 .....
3. This/ apple/ for/ is/ you.  
 .....
4. big/ Those/ clouds./ are  
 .....
5. is/ My/ doll/ green.  
 .....
6. on/ the table./ ten/ pens/ There are  
 .....
7. the/ aloud./ Read/ chant  
 .....
8. on/ are/ pictures/ the/ The/ wall.  
 .....
9. is/ bicycle/ My/ pink.  
 .....
10. me?/ Can/ help/ you  
 .....



**Exercises 4: Listen and choose the correct answer. (Nghe và chọn đáp án đúng). (Track 35)**

1. She's very .....  
a. nice                      b. fine                      c. careful                      d. kind
2. My mother looks very .....  
a. long                      b. fit                      c. strong                      d. sporty
3. My mother is ..... years old.  
a. thirty five                      b. thirty nine                      c. fifty five                      d. fifty nine
4. He likes ..... very much.  
a. walking                      b. dancing                      c. cooking                      d. joking
5. Tom's mother is kind and .....  
a. cheerful                      b. careful                      c. beautiful                      d. wonderful
6. She loves .....  
a. spring                      b. boards                      c. sports                      d. stop
7. What's your mother's favourite .....?  
a. book                      b. cook                      c. food                      d. soup
8. My teacher is ..... and kind.  
a. pretty                      b. lovely                      c. friendly                      d. happy
9. What does ..... look like?  
a. your sister                      b. your teacher                      c. your mother                      d. your doctor
10. What's she like? – She's .....  
a. joyful                      b. beautiful                      c. cheerful                      d. careful

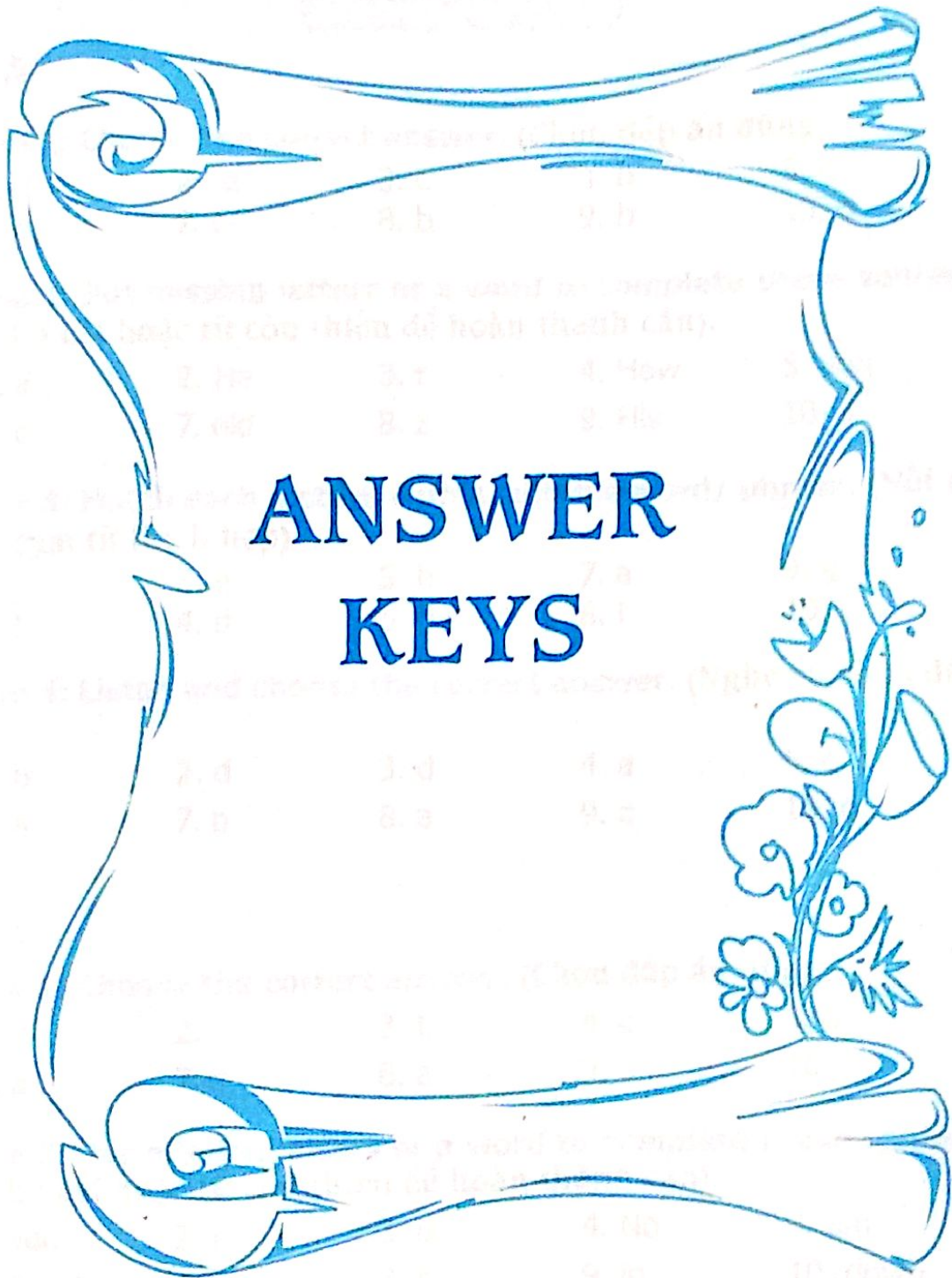

# ANSWER KEYS



# ROUND 1

## TEST A

**Exercise 1: Choose the correct answer.** (Chọn đáp án đúng).

- |      |      |      |      |       |
|------|------|------|------|-------|
| 1. d | 2. a | 3. c | 4. b | 5. c  |
| 6. c | 7. c | 8. b | 9. b | 10. b |

**Exercise 2: Put missing letters or a word to complete these sentences.**  
(Điền chữ cái hoặc từ còn thiếu để hoàn thành câu).

- |      |        |      |        |        |
|------|--------|------|--------|--------|
| 1. a | 2. He  | 3. r | 4. How | 5. you |
| 6. c | 7. old | 8. z | 9. His | 10. a  |

**Exercise 3: Match each picture with a suitable word/ phrase.** (Nối tranh với từ/ cụm từ thích hợp).

- |      |      |      |      |       |
|------|------|------|------|-------|
| 1. j | 3. e | 5. h | 7. a | 9. g  |
| 2. f | 4. d | 6. b | 8. i | 10. c |

**Exercise 4: Listen and choose the correct answer.** (Nghe và chọn đáp án đúng).

- |      |      |      |      |       |
|------|------|------|------|-------|
| 1. b | 2. d | 3. d | 4. a | 5. c  |
| 6. a | 7. b | 8. a | 9. c | 10. d |

## TEST B

**Exercise 1: Choose the correct answer.** (Chọn đáp án đúng).

- |      |      |      |      |       |
|------|------|------|------|-------|
| 1. c | 2.   | 3. b | 4. c | 5. a  |
| 6. a | 7. d | 8. a | 9. a | 10. c |

**Exercise 2: Put missing letters or a word to complete these sentences.**  
(Điền chữ cái hoặc từ còn thiếu để hoàn thành câu).

- |         |      |       |       |          |
|---------|------|-------|-------|----------|
| 1. you  | 2. r | 3. is | 4. No | 5. am    |
| 6. Good | 7. o | 8. s  | 9. in | 10. down |

**Exercise 3: Match each picture with a suitable word/ phrase.** (Nối tranh với từ/ cụm từ thích hợp).

- |      |      |      |      |       |
|------|------|------|------|-------|
| 1. j | 2. i | 3. a | 4. f | 5. b  |
| 6. c | 7. d | 8. e | 9. g | 10. h |



**Exercise 4: Listen and choose the correct answer.** (Nghe và chọn đáp án đúng). (Track 3)

- |      |      |      |      |       |
|------|------|------|------|-------|
| 1. a | 2. c | 3. d | 4. b | 5. a  |
| 6. d | 7. d | 8. b | 9. c | 10. a |

## ROUND 2

### TEST A

**Exercise 1: Match each picture with a suitable word/ phrase.** (Nối tranh với từ/ cụm từ thích hợp).

- |      |      |      |      |       |
|------|------|------|------|-------|
| 1. c | 2. f | 3. j | 4. a | 5. i  |
| 6. g | 7. b | 8. e | 9. h | 10. d |

**Exercise 2: Put missing letters or a word to complete these sentences.** (Điền chữ cái hoặc từ còn thiếu để hoàn thành câu).

- |        |       |       |        |        |
|--------|-------|-------|--------|--------|
| 1. ne  | 2. ld | 3. ar | 4. m   | 5. I   |
| 6. ool | 7. ou | 8. os | 9. nam | 10. en |

**Exercise 3: Reorder the words/ phrases to make complete sentences.** (Sắp xếp lại từ hoặc cụm từ để tạo thành câu hoàn chỉnh).

- How old are you?
- What is your name?
- Mary has two brothers.
- Peter is from Australia
- Her sister is my friend.
- It is a big box.
- There are many birds on the tree.
- Lan Anh is my best friend.
- That girl is Lan
- Linda and Peter are my friends.





**Exercise 4: Listen and choose what you hear** (Nghe và chọn phương án em nghe thấy). (Track 4)

- |      |      |      |      |       |
|------|------|------|------|-------|
| 1. c | 2. d | 3. d | 4. c | 5. c  |
| 6. c | 7. a | 8. b | 9. d | 10. d |

**TEST B**

**Exercise 1: Match each picture with a suitable word/ phrase.** (Nối tranh với từ/ cụm từ thích hợp).

- |      |      |      |      |       |
|------|------|------|------|-------|
| 1. f | 2. d | 3. g | 4. h | 5. a  |
| 6. j | 7. c | 8. b | 9. i | 10. e |

**Exercise 2: Put missing letters or a word to complete these sentences.** (Điền chữ cái hoặc từ còn thiếu để hoàn thành câu).

- |       |       |       |      |         |
|-------|-------|-------|------|---------|
| 1. Ho | 2. ld | 3. uc | 4. o | 5. n    |
| 6. i  | 7. n  | 8. f  | 9. a | 10. thi |

**Exercise 3: Reorder the words/ phrases to make complete sentences.** (Sắp xếp lại từ hoặc cụm từ để tạo thành câu hoàn chỉnh).

1. Hello, how are you?
2. Would you like some milk?
3. How old is your sister?
4. She can jump rope.
5. What is he doing?
6. This is my room.
7. How old is she?
8. She is very hungry.
9. How old are you?
10. Mary has two cats.

**Exercise 4: Listen and choose what you hear** (Nghe và chọn phương án em nghe thấy). (Track 5)

- |      |      |      |      |       |
|------|------|------|------|-------|
| 1. a | 2. d | 3. b | 4. b | 5. c  |
| 6. b | 7. c | 8. c | 9. b | 10. a |





# ROUND 3

## TEST A

**Exercise 1: Choose the correct answer. (Chọn đáp án đúng).**

- 1. c
- 2. c
- 3. a
- 4. c

**Exercise 2: Match each picture with a suitable word/ phrase. (Nối tranh với từ/ cụm từ thích hợp).**

- 1. e
- 3. i
- 5. a
- 7. h
- 9. d
- 2. b
- 4. j
- 6. f
- 8. c
- 10. g

**Exercise 3: Put missing letters or a word to complete these words/ sentences. (Điền chữ cái hoặc từ còn thiếu để hoàn thành từ/ câu).**

- 1. ro
- 2. ee
- 3. ld
- 4. he
- 5. f
- 6. is
- 7. e
- 8. an
- 9. an
- 10. oc

**Exercise 4: Listen and circle the correct photo. (Nghe và khoanh tròn hình đúng). (Track 6)**

	a	b	c	d
1		✓		
2	✓			
3			✓	
4				✓
5		✓		
6	✓			
7		✓		
8			✓	
9				✓
10			✓	

## TEST B

**Exercise 1: Choose the correct answer. (Chọn đáp án đúng).**

- 1. c
- 2. d
- 3. c
- 4. c



**Exercise 2: Match each picture with a suitable word/ phrase. (Nối tranh với từ/ cụm từ thích hợp).**

- 1. c
- 2. g
- 3. j
- 4. a
- 5. f
- 6. i
- 7. b
- 8. d
- 9. e
- 10. h

**Exercise 3: Put a letter to complete word. (Điền chữ cái còn thiếu để hoàn thành từ)**

- 1. O
- 2. S
- 3. s
- 4. ld
- 5. H
- 6. p
- 7. o
- 8. o
- 9. an
- 10. Y

**Exercise 4: Listen and tick the correct photo. (Nghe và chọn hình đúng).**  
(Track 7)

	a	b	c	d
1				✓
2		✓		
3	✓			
4			✓	
5				✓
6		✓		
7	✓			
8		✓		
9			✓	
10				✓

## ROUND 4

### TEST A

**Exercise 1: Choose the correct answer. (Chọn đáp án đúng).**

- 1. b
- 2. c
- 3. c
- 4. c
- 5. c
- 6. b
- 7. d
- 8. c
- 9. a
- 10. a

**Exercise 2: Put missing letters or a word to complete these sentences. (Điền chữ cái hoặc từ còn thiếu để hoàn thành câu).**

- 1. am
- 2. nk
- 3. e
- 4. in
- 5. old
- 6. ool
- 7. r
- 8. And
- 9. re
- 10. ea





**Exercise 3: Match each picture with a suitable word/ phrase.** (Nói tranh với từ/ cụm từ thích hợp).

- |      |      |      |      |       |
|------|------|------|------|-------|
| 1. f | 3. b | 5. j | 7. h | 9. e  |
| 2. c | 4. g | 6. d | 8. a | 10. i |

**Exercise 4: Listen and choose what you hear** (Nghe và chọn phương án em nghe thấy). (Track 8)

- |      |      |      |      |       |
|------|------|------|------|-------|
| 1. a | 3. a | 5. b | 7. d | 9. c  |
| 2. b | 4. d | 6. b | 8. a | 10. d |

## TEST B

**Exercise 1: Choose the correct answer.** (Chọn đáp án đúng).

- |      |      |      |      |       |
|------|------|------|------|-------|
| 1. c | 2. c | 3. a | 4. c | 5. d  |
| 6. b | 7. b | 8. d | 9. d | 10. c |

**Exercise 2: Put missing letters or a word to complete these sentences.** (Điền chữ cái hoặc từ còn thiếu để hoàn thành câu).

- |        |        |       |         |        |
|--------|--------|-------|---------|--------|
| 1. old | 2. for | 3. Is | 4. When | 5. a   |
| 6. he  | 7. is  | 8. o  | 9. s    | 10. ro |

**Exercise 3: Match each picture with a suitable word/ phrase.** (Nói tranh với từ/ cụm từ thích hợp).

- |      |      |      |      |       |
|------|------|------|------|-------|
| 1. e | 3. b | 5. g | 7. a | 9. f  |
| 2. h | 4. j | 6. c | 8. i | 10. d |

**Exercise 4: Listen and choose what you hear** (Nghe và chọn phương án em nghe thấy). (Track 9)

- |      |      |      |      |       |
|------|------|------|------|-------|
| 1. b | 3. b | 5. b | 7. c | 9. a  |
| 2. b | 4. d | 6. a | 8. b | 10. d |



## ROUND 5



### TEST A

**Exercise 1: Match each picture with a suitable word/ phrase.** (Nối tranh với từ/ cụm từ thích hợp).

- |      |      |      |      |       |
|------|------|------|------|-------|
| 1. e | 3. j | 5. b | 7. i | 9. f  |
| 2. a | 4. d | 6. g | 8. c | 10. h |

**Exercise 2: Reorder the words/ phrases to make complete sentences.** (Sắp xếp lại từ hoặc cụm từ để tạo thành câu hoàn chỉnh).

1. I am from America.
2. My brother doesn't like cat.
3. Peter wants some food.
4. Tom is my friend.
5. Would you like an ice-cream?
6. What would you like?
7. It's rainy in July.
8. What is her job?
9. Read the chant aloud.
10. Is this a desk?

**Exercise 3: Pick out one redundant letter to make the correct word.** (Bỏ một chữ cái thừa để có từ đúng).

- |              |              |
|--------------|--------------|
| 1. STASR     | 2. STUFDENT  |
| 3. WHUERE    | 4. PLEARSE   |
| 5. BIARTHDAY | 6. NOTESBOOK |
| 7. WDOULD    | 8. TSREE     |
| 9. SCHOIOL   | 10. CANGDLE  |

**Exercises 4: Listen and choose the correct answer.** (Nghe và chọn đáp án đúng). (Track 10)

- |      |      |      |      |       |
|------|------|------|------|-------|
| 1. a | 3. a | 5. b | 7. d | 9. a  |
| 2. b | 4. d | 6. c | 8. c | 10. d |



## TEST B

**Exercise 1: Match each picture with a suitable word/ phrase.** (Nối tranh với từ/ cụm từ thích hợp).

- |      |      |      |      |       |
|------|------|------|------|-------|
| 1. j | 3. e | 5. i | 7. c | 9. h  |
| 2. d | 4. a | 6. b | 8. g | 10. f |

**Exercise 2: Reorder the words/ phrases to make complete sentences.** (Sắp xếp lại từ hoặc cụm từ để tạo thành câu hoàn chỉnh).

- |                              |                                    |
|------------------------------|------------------------------------|
| 1. I have a book in my bag.  | 2. This doll is for you.           |
| 3. Jim is from England, too. | 4. When is your father's birthday? |
| 5. This is a robot.          | 6. She is from Singapore.          |
| 7. Is this a desk?           | 8. Good morning, teacher!          |
| 9. This gift is for you.     | 10. I am hungry now.               |

**Exercise 3: Pick out one redundant letter to make the correct word.** (Bỏ một chữ cái thừa để có từ đúng).

- |                      |                     |
|----------------------|---------------------|
| 1. BECAU <b>F</b> SE | 2. FIG <b>S</b> H   |
| 3. HOUS <b>Y</b> E   | 4. RS <b>U</b> LER  |
| 5. LOE <b>O</b> K    | 6. P <b>I</b> ENCIL |
| 7. WH <b>U</b> ERE   | 8. WH <b>I</b> TE   |
| 9. NUMB <b>W</b> ER  | 10. REA <b>Q</b> D  |

**Exercises 4: Listen and choose the correct answer.** (Nghe và chọn đáp án đúng). (Track 11)

- |      |      |      |      |       |
|------|------|------|------|-------|
| 1. d | 3. a | 5. d | 7. b | 9. b  |
| 2. b | 4. a | 6. c | 8. c | 10. d |



# ROUND 6

## TEST A

**Exercise 1: Put missing letters or a word to complete these sentences.**  
(Điền chữ cái hoặc từ còn thiếu để hoàn thành câu).

- 1. Can
- 2. ee
- 3. c
- 4. can

**Exercise 2: Match each picture with a suitable word/ phrase.** (Nối tranh với từ/ cụm từ thích hợp).

- 1. h
- 2. d
- 3. b
- 4. g
- 5. j
- 6. e
- 7. i
- 8. a
- 9. c
- 10. f

**Exercise 3: Match each picture with a suitable word/ phrase.** (Nối tranh với từ/ cụm từ thích hợp).

- 1. TABØLE
- 2. BECAUFSE
- 3. CAYKE
- 4. LIØKE
- 5. WHYM
- 6. WRIETE
- 7. SCHPOOL
- 8. BREAJD
- 9. STHAND
- 10. SWIMM

**Exercise 4: Listen and choose the correct answer.** (Nghe và chọn đáp án đúng). (Track 12)

	a	b	c	d
1		✓		
2	✓			
3			✓	
4	✓			
5		✓		
6			✓	
7				✓
8		✓		
9	✓			
10				✓



### TEST B

**Exercise 1: Put missing letters or a word to complete these sentences.**  
(Điền chữ cái hoặc từ còn thiếu để hoàn thành câu).

- 1. and
- 2. o
- 3. r
- 4. Yes

**Exercise 2: Match each picture with a suitable word/ phrase.** (Nối tranh với từ/ cụm từ thích hợp).

- 1. c
- 3. i
- 5. e
- 7. b
- 9. h
- 2. f
- 4. a
- 6. g
- 8. j
- 10. d

**Exercise 3: Pick out one redundant letter to make the correct word.** (Bỏ một chữ cái thừa để có từ đúng).

- 1. SIENG
- 2. FRIAEND
- 3. PIZYZA
- 4. SCHPOOL
- 5. DANCFE
- 6. WHIEN
- 7. PLAIY
- 8. LISTKEN
- 9. CANFNOT
- 10. VIETNAMMESE

**Exercise 4: Listen and tick the correct photo.** (Nghe và chọn hình đúng).  
(Track 13)

	a	b	c	d
1				✓
2			✓	
3		✓		
4			✓	
5	✓			
6		✓		
7			✓	
8	✓			
9				✓
10		✓		



# ROUND 7

## TEST A

**Exercise 1: Match each picture with a suitable word/ phrase.** (Nói tranh với từ/ cụm từ thích hợp).

- |      |      |      |      |       |
|------|------|------|------|-------|
| 1. c | 3. i | 5. e | 7. b | 9. f  |
| 2. g | 4. a | 6. j | 8. h | 10. d |

**Exercise 2: Put missing letters or a word to complete these sentences.** (Điền chữ cái hoặc từ còn thiếu để hoàn thành câu).

- |       |        |       |       |          |
|-------|--------|-------|-------|----------|
| 1. em | 2. ld  | 3. It | 4. up | 5. ou    |
| 6. Wh | 7. ude | 8. la | 9. fr | 10. What |

**Exercise 3: Choose the correct answer.** (Chọn đáp án đúng).

- |      |      |      |      |       |
|------|------|------|------|-------|
| 1. b | 2. a | 3. a | 4. c | 5. d  |
| 6. c | 7. a | 8. b | 9. d | 10. d |

**Exercises 4: Listen and choose the correct answer.** (Nghe và chọn đáp án đúng). (Track 14)

- |      |      |      |      |       |
|------|------|------|------|-------|
| 1. b | 3. d | 5. c | 7. b | 9. c  |
| 2. a | 4. a | 6. d | 8. b | 10. d |

## TEST B

**Exercise 1: Match each picture with a suitable word/ phrase.** (Nói tranh với từ/ cụm từ thích hợp).

- |      |      |      |      |       |
|------|------|------|------|-------|
| 1. c | 3. j | 5. e | 7. b | 9. i  |
| 2. g | 4. a | 6. h | 8. f | 10. d |

**Exercise 2: Put missing letters or a word to complete these sentences.** (Điền chữ cái hoặc từ còn thiếu để hoàn thành câu).

- |       |       |         |          |        |
|-------|-------|---------|----------|--------|
| 1. ut | 2. im | 3. a    | 4. asroo | 5. u   |
| 6. an | 7. w  | 8. rthd | 9. il    | 10. la |





**Exercise 3: Choose the correct answer. (Chọn đáp án đúng).**

- |      |      |      |      |       |
|------|------|------|------|-------|
| 1. a | 2. b | 3. d | 4. b | 5. d  |
| 6. d | 7. a | 8. b | 9. d | 10. a |

**Exercises 4: Listen and choose the correct answer. (Nghe và chọn đáp án đúng). (Track 15)**

- |      |      |      |      |       |
|------|------|------|------|-------|
| 1. b | 3. b | 5. c | 7. b | 9. a  |
| 2. a | 4. b | 6. b | 8. d | 10. b |

**ROUND 8**

**TEST A**

**Exercise 1: Put missing letters or a word to complete these sentences. (Điền chữ cái hoặc từ còn thiếu để hoàn thành câu).**

1. A bird can fly.
2. Mary is in the classroom now.
3. I am from England.
4. Hung can play football but he cannot dance.
5. Let's sing an English song.
6. Is your school big or small?
7. This is my family.
8. Mary can speak Vietnamese.
9. I like chocolate very much.
10. My sister can sing.

**Exercise 2: Match each picture with a suitable word/ phrase. (Nối tranh với từ/ cụm từ thích hợp).**

- |      |      |      |      |       |
|------|------|------|------|-------|
| 1. g | 3. a | 5. f | 7. j | 9. c  |
| 2. d | 4. h | 6. b | 8. e | 10. i |

**Exercise 3: Choose the correct answer. (Chọn đáp án đúng).**

- |      |      |      |      |       |
|------|------|------|------|-------|
| 1. b | 2. c | 3. c | 4. c | 5. c  |
| 6. b | 7. c | 8. b | 9. b | 10. c |





**Exercise 4: Listen and tick the correct photo. (Nghe và chọn hình đúng).**  
(Track 18)

	a	b	c	d
1	✓			
2		✓		
3				✓
4		✓		
5	✓			
6			✓	
7		✓		
8				✓
9	✓			
10			✓	

**TEST B**

**Exercise 1: Reorder the words/ phrases to make complete sentences.**  
(Sắp xếp lại từ hoặc cụm từ để tạo thành câu hoàn chỉnh).

1. This banana is for you.
2. Here are some flowers for my teacher.
3. Is your school big or small?
4. I am from England.
5. Tom can ride a bicycle.
6. It is a long pencil.
7. Happy birthday to you, Jenny.
8. I have two cats.
9. I can dance and sing.
10. Please give me some more.

**Exercise 2: Match each picture with a suitable word/ phrase. (Nối tranh với từ/ cụm từ thích hợp).**

- |      |      |      |      |       |
|------|------|------|------|-------|
| 1. c | 3. h | 5. j | 7. b | 9. g  |
| 2. e | 4. a | 6. f | 8. i | 10. d |

**Exercise 3: Choose the correct answer. (Chọn đáp án đúng).**

- |      |      |      |      |       |
|------|------|------|------|-------|
| 1. a | 2. d | 3. b | 4. c | 5. a  |
| 6. d | 7. b | 8. d | 9. c | 10. b |







**Exercise 4: Listen and tick the correct photo. (Nghe và chọn hình đúng).**  
(Track 17)

	a	b	c	d
1			✓	
2	✓			
3		✓		
4				✓
5			✓	
6	✓			
7			✓	
8	✓			
9				✓
10		✓		

**ROUND 9**

**TEST A**

**Exercise 1: Match each picture with a suitable word/ phrase. (Nối tranh với từ/ cụm từ thích hợp).**

- 1. b
- 3. f
- 5. j
- 7. i
- 9. c
- 2. g
- 4. d
- 6. a
- 8. h
- 10. e

**Exercise 2: Put missing letters or a word to complete these sentences. (Điền chữ cái hoặc từ còn thiếu để hoàn thành câu).**

- 1. s
- 2. n
- 3. n
- 4. re
- 5. se
- 6. k
- 7. ld
- 8. l
- 9. is, a
- 10. or

**Exercise 3: Choose the correct answer. (Chọn đáp án đúng).**

- 1. b
- 2. a
- 3. a
- 4. d



**Exercise 4: Listen and choose the correct answer.** (Nghe và chọn đáp án đúng). (Track 18)

	a	b	c	d
1		✓		
2	✓			
3			✓	
4				✓
5	✓			
6			✓	
7	✓			
8				✓
9		✓		
10	✓			

**TEST B**

**Exercise 1: Match each picture with a suitable word/ phrase.** (Nối tranh với từ/ cụm từ thích hợp).

- 1. f
- 3. b
- 5. g
- 7. i
- 9. c
- 2. d
- 4. j
- 6. e
- 8. a
- 10. h

**Exercise 2: Put missing letters or a word to complete these sentences.** (Điền chữ cái hoặc từ còn thiếu để hoàn thành câu).

- 1. Wh
- 2. we
- 3. your
- 4. la
- 5. is
- 6. Thi
- 7. v
- 8. ow
- 9. ea
- 10. o

**Exercise 3: Choose the correct answer.** (Chọn đáp án đúng).

- 1. c
- 2. c
- 3. b
- 4. c





**Exercise 4: Listen and choose the correct answer.** (Nghe và chọn đáp án đúng). (Track 19)

	a	b	c	d
1			✓	
2				✓
3	✓			
4		✓		
5				✓
6	✓			
7			✓	
8		✓		
9				✓
10		✓		

## ROUND 10

### TEST A

**Exercise 1: Choose the correct answer.** (Chọn đáp án đúng).

1. d      2. c      3. d      4. c      5. d  
6. d      7. a      8. c      9. b      10. a

**Exercise 2: Match each picture with a suitable word/ phrase.** (Nối tranh với từ/ cụm từ thích hợp).

1. a      3. f      5. j      7. c      9. i  
2. d      4. b      6. h      8. e      10. g

**Exercise 3: Put missing letters or a word to complete these sentences.**  
(Điền chữ cái hoặc từ còn thiếu để hoàn thành câu).

1. are      2. T      3. am      4. a      5. ll  
6. oo      7. How      8. ou      9. pp      10. T



**Exercise 4: Listen and choose what you hear** (Nghe và chọn phương án em nghe thấy). (Track 20)

- |      |      |      |      |       |
|------|------|------|------|-------|
| 1. a | 3. b | 5. c | 7. a | 9. c  |
| 2. b | 4. d | 6. d | 8. d | 10. b |

### TEST B

**Exercise 1: Choose the correct answer.** (Chọn đáp án đúng).

- |      |      |      |      |       |
|------|------|------|------|-------|
| 1. c | 3. d | 5. a | 7. c | 9. b  |
| 2. d | 4. a | 6. c | 8. b | 10. a |

**Exercise 2: Match each picture with a suitable word/ phrase.** (Nối tranh với từ/ cụm từ thích hợp).

- |      |      |      |      |       |
|------|------|------|------|-------|
| 1. j | 3. a | 5. d | 7. i | 9. g  |
| 2. c | 4. h | 6. f | 8. b | 10. e |

**Exercise 3: Put missing letters or a word to complete these sentences.**

(Điền chữ cái hoặc từ còn thiếu để hoàn thành câu).

- |       |       |        |       |         |
|-------|-------|--------|-------|---------|
| 1. es | 3. ld | 5. ate | 7. is | 9. any  |
| 2. uc | 4. n  | 6. G   | 8. E  | 10. ver |

**Exercise 4: Listen and choose what you hear** (Nghe và chọn phương án em nghe thấy). (Track 21)

- |      |      |      |      |       |
|------|------|------|------|-------|
| 1. a | 3. a | 5. d | 7. d | 9. c  |
| 2. c | 4. c | 6. a | 8. a | 10. d |

## ROUND 11

### TEST A

**Exercise 1: Pick out one redundant letter to make the correct word.** (Bỏ một chữ cái thừa để có từ đúng).

- |          |               |
|----------|---------------|
| 1. WALJL | 2. MIRROHR    |
| 3. EHAT  | 4. CLASSGROOM |



- 5. SBKY
- 6. MUSQIC
- 7. DESJK
- 8. SINGERR
- 9. CHĐAIR
- 10. CLOPCK

**Exercise 2: Reorder the words/phrases to make complete sentences.**  
(Sắp xếp lại từ hoặc cụm từ để tạo thành câu hoàn chỉnh).

1. There are two pencil boxes.
2. Mary has two dolls.
3. This gift is for you.
4. This is a green shirt.
5. Would you like an ice-cream?
6. I like English very much.
7. It's hot today.
8. Mary is a student at Oxford Primary School.
9. She can sing and dance.
10. This is our calssroom.

**Exercise 3: Match each picture with a suitable word/ phrase.** (Nối tranh với từ/ cụm từ thích hợp).

- |      |      |      |      |       |
|------|------|------|------|-------|
| 1. d | 3. j | 5. c | 7. f | 9. i  |
| 2. g | 4. a | 6. h | 8. b | 10. e |

**Exercises 4: Listen and choose the correct answer.** (Nghe và chọn đáp án đúng). (Track 22)

- |      |      |      |      |       |
|------|------|------|------|-------|
| 1. d | 3. d | 5. d | 7. c | 9. c  |
| 2. b | 4. b | 6. c | 8. a | 10. d |

**TEST B**

**Exercise 1: Pick out one redundant letter to make the correct word.** (Bỏ một chữ cái thừa để có từ đúng).

- |              |               |
|--------------|---------------|
| 1. PICTGURE  | 2. PIQG       |
| 3. QUESTINON | 4. FISRH      |
| 5. FLOWKER   | 6. SNŪEAKERS  |
| 7. RUØLER    | 8. LISTGEN    |
| 9. KIXTCHEN  | 10. EENGINEER |



**Exercise 2: Reorder the words/ phrases to make complete sentences.**

(Sắp xếp lại từ hoặc cụm từ để tạo thành câu hoàn chỉnh).

1. My toys are in the brown box.
2. My books are on the bookshelf.
3. Mary has two dolls.
4. Can you remember my birthday?
5. Where are you from, Tommy?
6. Where are the books and notebooks?
7. The weather is sunny today.
8. It's so hot today.
9. She can play football and tennis.
10. She is ten years old.

**Exercise 3: Match each picture with a suitable word/ phrase. (Nối tranh với từ/ cụm từ thích hợp).**

- |      |      |      |      |       |
|------|------|------|------|-------|
| 1. f | 3. b | 5. j | 7. g | 9. e  |
| 2. d | 4. h | 6. a | 8. c | 10. i |

**Exercises 4: Listen and choose the correct answer. (Nghe và chọn đáp án đúng). (Track 23)**

- |      |      |      |      |       |
|------|------|------|------|-------|
| 1. c | 3. d | 5. c | 7. b | 9. a  |
| 2. b | 4. d | 6. a | 8. a | 10. b |

**ROUND 12**

**TEST A**

**Exercise 1: Put missing letters or a word to complete these sentences.**

(Điền chữ cái hoặc từ còn thiếu để hoàn thành câu).

- |        |        |       |      |
|--------|--------|-------|------|
| 1. rth | 2. oom | 3. el | 4. o |
|--------|--------|-------|------|

**Exercise 2: Pick out one redundant letter to make the correct word. (Bỏ một chữ cái thừa để có từ đúng).**

- |             |            |
|-------------|------------|
| 1. GIFTI    | 2. SPETAK  |
| 3. WAMLL    | 4. BANWANA |
| 5. ENGLRAND | 6. WRINTE  |
| 7. WELCOSME | 8. HXOT    |
| 9. FRIENSĐ  | 10. DANŁCE |





**Exercise 3: Match each picture with a suitable word/ phrase.** (Nối tranh với từ/ cụm từ thích hợp).

1. b                      3. f                      5. l                      7. c                      9. h  
2. d                      4. j                      6. a                      8. g                      10. e

**Exercise 4: Listen and tick the correct photo.** (Nghe và chọn hình đúng).

	a	b	c	d
1			✓	
2	✓			
3		✓		
4				✓
5	✓			
6		✓		
7	✓			
8		✓		
9	✓			
10			✓	

### TEST B

**Exercise 1: Put missing letters or a word to complete these sentences.** (Điền chữ cái hoặc từ còn thiếu để hoàn thành câu).

1. pea                      2. oo                      3. av                      4. are

**Exercise 2: Pick out one redundant letter to make the correct word.** (Bỏ một chữ cái thừa để có từ đúng).

1. SOKNG	2. ROBOET
3. STUDEKNT	4. TABCLE
5. KITCHXEN	6. NATME
7. APPLVE	8. NUMBWER
9. GAØRDEN	10. MØONKEY



**Exercise 3: Match each picture with a suitable word/ phrase. (Nối tranh với từ/ cụm từ thích hợp).**

- 1. c                      3. j                      5. i                      7. b                      9. h
- 2. f                      4. a                      6. e                      8. g                      10. d

**Exercise 4: Listen and tick the correct photo. (Nghe và chọn hình đúng).**  
(Track 25)

	a	b	c	d
1	✓			
2				✓
3	✓			
4		✓		
5				✓
6			✓	
7				✓
8			✓	
9		✓		
10	✓			

## ROUND 13

### TEST A

**Exercise 1: Put missing letters or a word to complete these sentences.**  
(Điền chữ cái hoặc từ còn thiếu để hoàn thành câu).

- 1. No
- 2. ir
- 3. eve
- 4. ien
- 5. jec
- 6. an
- 7. rr
- 8. oo
- 9. ir
- 10. abb







**Exercise 2: Match each picture with a suitable word/ phrase.** (Nối tranh với từ/ cụm từ thích hợp).

- |      |      |      |      |       |
|------|------|------|------|-------|
| 1. c | 3. e | 5. g | 7. b | 9. j  |
| 2. h | 4. a | 6. i | 8. f | 10. d |

**Exercise 3: Choose the correct answer.** (Chọn đáp án đúng).

- |      |      |      |      |
|------|------|------|------|
| 1. c | 2. a | 3. a | 4. a |
|------|------|------|------|

**Exercise 4: Listen and choose what you hear** (Nghe và chọn phương án em nghe thấy). (Track 26)

- |      |      |      |      |       |
|------|------|------|------|-------|
| 1. a | 3. b | 5. b | 7. a | 9. d  |
| 2. d | 4. d | 6. d | 8. d | 10. c |

## TEST B

**Exercise 1: Put missing letters or a word to complete these sentences.** (Điền chữ cái hoặc từ còn thiếu để hoàn thành câu).

- |       |        |       |       |        |
|-------|--------|-------|-------|--------|
| 1. w  | 2. ob  | 3. on | 4. bl | 5. Her |
| 6. th | 7. ave | 8. an | 9. ow | 10. IC |

**Exercise 2: Match each picture with a suitable word/ phrase.** (Nối tranh với từ/ cụm từ thích hợp).

- |      |      |      |      |       |
|------|------|------|------|-------|
| 1. a | 3. d | 5. j | 7. c | 9. g  |
| 2. h | 4. b | 6. f | 8. i | 10. e |

**Exercise 3: Choose the correct answer.** (Chọn đáp án đúng).

- |      |      |      |      |
|------|------|------|------|
| 1. b | 2. a | 3. b | 4. a |
|------|------|------|------|

**Exercise 4: Listen and choose what you hear** (Nghe và chọn phương án em nghe thấy). (Track 27)

- |      |      |      |      |       |
|------|------|------|------|-------|
| 1. b | 3. a | 5. b | 7. c | 9. d  |
| 2. c | 4. c | 6. a | 8. a | 10. b |





## ROUND 14

### TEST A

**Exercise 1: Reorder the words/ phrases to make complete sentences.**  
(Sắp xếp lại từ hoặc cụm từ để tạo thành câu hoàn chỉnh).

1. Take out your pencils, children.
2. Do you like some orange juice?
3. My sister can ride a bike.
4. Here are some flowers for you.
5. I have two dolls.
6. How many students are there in your classroom?
7. Clean your room, Peter.
8. What do you do during Music lessons?
9. My bedroom is very small.
10. Jack is a student at London Primary School.

**Exercise 2: Choose the correct answer.** (Chọn đáp án đúng).

- |      |      |      |      |       |
|------|------|------|------|-------|
| 1. b | 2. a | 3. c | 4. d | 5. a  |
| 6. c | 7. c | 8. b | 9. b | 10. b |

**Exercise 3: Match each picture with a suitable word/ phrase.** (Nối tranh với từ/ cụm từ thích hợp).

- |      |      |      |      |       |
|------|------|------|------|-------|
| 1. c | 3. f | 5. j | 7. b | 9. e  |
| 2. h | 4. a | 6. g | 8. i | 10. d |

**Exercises 4: Listen and choose the correct answer.** (Nghe và chọn đáp án đúng). (Track 28)

- |      |      |      |      |       |
|------|------|------|------|-------|
| 1. b | 3. a | 5. c | 7. c | 9. c  |
| 2. c | 4. a | 6. a | 8. d | 10. b |

### TEST B

**Exercise 1: Reorder the words/ phrases to make complete sentences.**  
(Sắp xếp lại từ hoặc cụm từ để tạo thành câu hoàn chỉnh).

1. I want to stay at home.

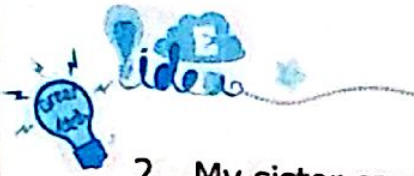

2. My sister can play with a Yo yo.
3. We don't have music on Wednesday.
4. It's nice to see you.
5. I have many pens in my school bag.
6. What's the weather like today?
7. Do you like some orange juice?
8. I don't like chicken.
9. My sister can dance and sing.
10. Maths is my favourite subject.

**Exercise 2: Choose the correct answer. (Chọn đáp án đúng).**

- |      |      |      |      |       |
|------|------|------|------|-------|
| 1. a | 2. d | 3. a | 4. c | 5. c  |
| 6. d | 7. c | 8. c | 9. c | 10. a |

**Exercise 3: Match each picture with a suitable word/ phrase. (Nối tranh với từ/ cụm từ thích hợp).**

- |      |      |      |      |       |
|------|------|------|------|-------|
| 1. c | 3. f | 5. j | 7. b | 9. i  |
| 2. g | 4. a | 6. h | 8. d | 10. e |

**Exercises 4: Listen and choose the correct answer. (Nghe và chọn đáp án đúng). Track 29)**

- |      |      |      |      |       |
|------|------|------|------|-------|
| 1. b | 3. b | 5. a | 7. d | 9. b  |
| 2. d | 4. c | 6. d | 8. c | 10. b |

**ROUND 15**

**TEST A**

**Exercise 1: Put missing letters or a word to complete these sentences. (Điền chữ cái hoặc từ còn thiếu để hoàn thành câu).**

- |        |        |       |        |        |
|--------|--------|-------|--------|--------|
| 1. nts | 2. uc  | 3. rr | 4. den | 5. av  |
| 6. Yes | 7. you | 8. of | 9. ou  | 10. es |





**Exercise 2: Choose the correct answer. (Chọn đáp án đúng).**

- 1. c
- 2. a
- 3. c
- 4. c

**Exercise 3: Match each picture with a suitable word/ phrase. (Nối tranh với từ/ cụm từ thích hợp).**

- 1. e
- 3. i
- 5. d
- 7. h
- 9. f
- 2. j
- 4. a
- 6. g
- 8. b
- 10. c

**Exercises 4: Listen and choose the correct answer. (Nghe và chọn đáp án đúng). (Track 30)**

- 1. b
- 3. a
- 5. a
- 7. d
- 9. d
- 2. c
- 4. c
- 6. c
- 8. a
- 10. c

**TEST B**

**Exercise 1: Put missing letters or a word to complete these sentences. (Điền chữ cái hoặc từ còn thiếu để hoàn thành câu).**

- 1. meet
- 2. app
- 3. What
- 4. e
- 5. w
- 6. hen
- 7. han
- 8. e
- 9. n
- 10. year

**Exercise 2: Choose the correct answer. (Chọn đáp án đúng).**

- 1. a
- 2. c
- 3. c
- 4. b

**Exercise 3: Match each picture with a suitable word/ phrase. (Nối tranh với từ/ cụm từ thích hợp).**

- 1. f
- 3. a
- 5. g
- 7. i
- 9. e
- 2. c
- 4. j
- 6. d
- 8. b
- 10. h

**Exercises 4: Listen and choose the correct answer. (Nghe và chọn đáp án đúng).**

- 1. c
- 3. c
- 5. c
- 7. d
- 9. d
- 2. b
- 4. d
- 6. d
- 8. c
- 10. a



## ROUND 16

### TEST A

**Exercise 1: Choose the correct answer.** (Chọn đáp án đúng).

1. a                      2. c                      3. a                      4. a

**Exercise 2: Put missing letters or a word to complete these sentences.**  
(Điền chữ cái hoặc từ còn thiếu để hoàn thành câu).

1. lis                      2. an                      3. e                      4. ri                      5. ou  
6. ou                      7. e                      8. s                      9. re                      10. for

**Exercise 3: Match each picture with a suitable word/ phrase.** (Nối tranh với từ/ cụm từ thích hợp).

1. h                      3. a                      5. e                      7. i                      9. d  
2. c                      4. j                      6. g                      8. b                      10. f

**Exercise 4: Listen and choose what you hear** (Nghe và chọn phương án em nghe thấy). (Track 32)

1. c                      3. c                      5. b                      7. c                      9. c  
2. d                      4. a                      6. b                      8. d                      10. d

### TEST B

**Exercise 1: Choose the correct answer.** (Chọn đáp án đúng).

1. a                      2. b                      3. a                      4. b

**Exercise 2: Put missing letters or a word to complete these sentences.**  
(Điền chữ cái hoặc từ còn thiếu để hoàn thành câu).

1. ro                      2. re                      3. ide                      4. Ho                      5. ter  
6. ol                      7. Yes                      8. a                      9. oo                      10. from

**Exercise 3: Match each picture with a suitable word/ phrase.** (Nối tranh với từ/ cụm từ thích hợp).

1. e                      3. a                      5. f                      7. i                      9. c  
2. h                      4. j                      6. d                      8. b                      10. g

**Exercise 4: Listen and choose what you hear** (Nghe và chọn phương án em nghe thấy). (Track 33)

1. d                      3. a                      5. d                      7. b                      9. b  
2. d                      4. c                      6. c                      8. a                      10. d

## ROUND 17

### TEST A

**Exercise 1: Pick out one redundant letter to make the correct word.** (Bỏ một chữ cái thừa để có từ đúng).

1. APPWLE
2. MIALK
3. MAFRCH
4. WHUAT
5. BROBWN
6. OPĐEN
7. SEKY
8. WHQEN
9. CHANIR
10. THAHNK

**Exercise 2: Match each picture with a suitable word/ phrase.** (Nối tranh với từ/ cụm từ thích hợp).

- |      |      |      |      |       |
|------|------|------|------|-------|
| 1. e | 3. j | 5. h | 7. b | 9. f  |
| 2. g | 4. a | 6. d | 8. i | 10. c |

**Exercise 3: Reorder the words/ phrases to make complete sentences.** (Sắp xếp lại từ hoặc cụm từ để tạo thành câu hoàn chỉnh).

1. Can you fly a kite?
2. It is Monday today.
3. How many rulers are there?
4. How many toys are there in that box?
5. I would like a banana.
6. I have English lessons on Monday.
7. There are twenty students in my class.
8. Her favourite subject is Music.
9. I can fly a kite.
10. How many crayons are there?

**Exercises 4: Listen and choose the correct answer.** (Nghe và chọn đáp án đúng). (Track 34)

- |      |      |      |      |       |
|------|------|------|------|-------|
| 1. b | 3. a | 5. c | 7. a | 9. c  |
| 2. c | 4. b | 6. d | 8. d | 10. a |

## TEST B

**Exercise 1: Pick out one redundant letter to make the correct word.** (Bỏ một chữ cái thừa để có từ đúng).

- |               |            |
|---------------|------------|
| 1. BEDROVOM   | 2. ROBWOT  |
| 3. ANSWGER    | 4. WHQEN   |
| 5. TABQLE     | 6. BOLLE   |
| 7. MOTRORBIKE | 8. CANVDLE |
| 9. CANSDY     | 10. CAZKE  |

**Exercise 2: Match each picture with a suitable word/ phrase.** (Nối tranh với từ/ cụm từ thích hợp).

- |      |      |      |      |       |
|------|------|------|------|-------|
| 1. h | 3. a | 5. f | 7. c | 9. g  |
| 2. e | 4. j | 6. b | 8. i | 10. d |

**Exercise 3: Reorder the words/ phrases to make complete sentences.** (Sắp xếp lại từ hoặc cụm từ để tạo thành câu hoàn chỉnh).

1. These are my new notebooks.
2. Listen to what the teacher says.
3. This apple is for you.
4. Those clouds are big.
5. My doll is green.
6. There are ten pens on the table.
7. Read the chant aloud.
8. The pictures are on the wall.
9. My bicycle is pink.
10. Can you help me?

**Exercises 4: Listen and choose the correct answer.** (Nghe và chọn đáp án đúng). (Track 35)

- |      |      |      |      |       |
|------|------|------|------|-------|
| 1. a | 3. d | 5. b | 7. a | 9. a  |
| 2. c | 4. b | 6. c | 8. b | 10. d |

200/16  
200/16



# TRANSCRIPTS

1. there 3 kitchen 4. art  
2. summer 5 student 2 apple

- 1. This is my...
- 2. This is my...
- 3. This is my...
- 4. This is my...
- 5. This is my...
- 6. This is my...
- 7. This is my...
- 8. This is my...
- 9. This is my...
- 10. This is my...



## ROUND 1

### TEST A

Exercise 4: Listen and tick the correct photo. (Nghe và chọn hình đúng).

(Track 2)

- |           |         |           |            |            |
|-----------|---------|-----------|------------|------------|
| 1. house  | 2. tent | 3. pencil | 4. teacher | 5. England |
| 6. stones | 7. ball | 8. sunny  | 9. table   | 10. fruits |

### TEST B

Exercise 4: Listen and tick the correct photo. (Nghe và chọn hình đúng).

(Track 3)

- |           |           |            |          |            |
|-----------|-----------|------------|----------|------------|
| 1. driver | 2. nurse  | 3. kitchen | 4. arts  | 5. January |
| 6. sing   | 7. farmer | 8. student | 9. apple | 10. Japan  |

## ROUND 2

### TEST A

Exercise 4: Listen and choose what you hear (Nghe và chọn phương án em nghe thấy). (Track 4)

- |                       |                           |
|-----------------------|---------------------------|
| 1. He's Mr. Bean      | 2. This is my brother.    |
| 3. Where are you now? | 4. How old are you, Bill? |
| 5. I'm Leo.           | 6. Teacher                |
| 7. I'm hot.           | 8. House                  |
| 9. I'm from England.  | 10. Father                |

### TEST B

Exercise 4: Listen and choose what you hear (Nghe và chọn phương án em nghe thấy). (Track 5)

- |                            |                         |
|----------------------------|-------------------------|
| 1. Let's play volleyball.  | 2. Good morning, John!  |
| 3. Bathroom                | 4. This is my father.   |
| 5. Swimming pool           | 6. He is right.         |
| 7. My new friend is Peter. | 8. Where are they from? |
| 9. Brother                 | 10. I'm hot.            |



## ROUND 3

### TEST A

**Exercise 4: Listen and tick the correct photo.** (Nghe và chọn hình đúng).  
(Track 6)

- |          |         |             |              |           |
|----------|---------|-------------|--------------|-----------|
| 1. drive | 2. boat | 3. hot      | 4. classroom | 5. car    |
| 6. cake  | 7. van  | 8. November | 9. cock      | 10. grape |

### TEST B

**Exercise 4: Listen and tick the correct photo.** (Nghe và chọn hình đúng).  
(Track 7)

- |          |          |             |           |            |
|----------|----------|-------------|-----------|------------|
| 1. write | 2. dog   | 3. rainy    | 4. castle | 5. train   |
| 6. chair | 7. train | 8. December | 9. clock  | 10. orange |

## ROUND 4

### TEST A

**Exercise 4: Listen and choose what you hear** (Nghe và chọn phương án em nghe thấy). (Track 8)

- |                               |                           |
|-------------------------------|---------------------------|
| 1. She likes dancing.         | 2. Who is that?           |
| 3. Music club                 | 4. She likes watching TV. |
| 5. We have two brothers.      | 6. He is nice.            |
| 7. It's in December.          | 8. When's your birthday?  |
| 9. The weather is sunny here. | 10. What can she do?      |

### TEST B

**Exercise 4: Listen and choose what you hear** (Nghe và chọn phương án em nghe thấy). (Track 9)

- |                            |                           |
|----------------------------|---------------------------|
| 1. I like dancing.         | 2. When's his birthday?   |
| 3. He rides a camel.       | 4. My birthday is in May. |
| 5. Wake up                 | 6. I can draw.            |
| 7. What's the date today?  | 8. Bookshelf              |
| 9. Can you draw a picture? | 10. I have some pencils.  |



## ROUND 5

### TEST A

**Exercises 4: Listen and choose the correct answer.** (Nghe và chọn đáp án đúng). (Track 10)

1. My birthday is on the first of October.
2. I chat with my friends when I have free time.
3. Can you swim?
4. We are going to swimming class now.
5. I like cooking.
6. Are you Japanese?
7. Do you like knitting?
8. He can use a computer.
9. She likes listening to music.
10. It's the third of October.

### TEST B

**Exercises 4: Listen and choose the correct answer.** (Nghe và chọn đáp án đúng). (Track 11)

1. She comes from Germany.
2. We are going to the Music club tonight.
3. What class are you in?
4. I like skipping.
5. Are you Korean?
6. She likes listening to Korean songs.
7. It's the fifth of October.
8. Do you like teaching?
9. Are you English?
10. They're all tired after school.

## ROUND 6

### TEST A

**Exercise 4: Listen and tick the correct photo.** (Nghe và chọn hình đúng). (Track 12)

- |                 |            |          |                 |             |
|-----------------|------------|----------|-----------------|-------------|
| 1. happy        | 2. Monday  | 3. glass | 4. table tennis | 5. fish     |
| 6. ride a camel | 7. drawing | 8. candy | 9. dress        | 10. evening |





## TEST B

**Exercise 4: Listen and tick the correct photo.** (Nghe và chọn hình đúng).

(Track 13)

- |                |              |           |              |             |
|----------------|--------------|-----------|--------------|-------------|
| 1. headache    | 2. Wednesday | 3. map    | 4. badminton | 5. friends  |
| 6. ride a bike | 7. dancing   | 8. candle | 9. glass     | 10. morning |

## ROUND 7

### TEST A

**Exercises 4: Listen and choose the correct answer.** (Nghe và chọn đáp án đúng). (Track 14)

1. What grade are you in?
2. Today is Monday.
3. I have got Music on Monday and Tuesday.
4. On Saturday, we go out for breakfast.
5. On Thursday morning, we play football.
6. I have got Vietnamese twice a week.
7. What is your favourite subject?
8. Arts is Mai's favourite subject.
9. Let's run!
10. There is a big map on the wall.

### TEST B

**Exercises 4: Listen and choose the correct answer.** (Nghe và chọn đáp án đúng). (Track 15)

1. I like English and Maths.
2. Have you got Physics today?
3. I go to school from Monday to Friday.
4. What lessons have you got today?
5. I don't have English on Friday.
6. I can't play badminton and volleyball.
7. On Sunday morning, we play football.



8. We don't go shopping on Sunday evening.
9. He has got four favourite subjects.
10. I have got a new roommate, his name is Tim.



## ROUND 8

### TEST A

**Exercise 4: Listen and tick the correct photo.** (Nghe và chọn hình đúng).

(Track 16)

- |             |             |          |            |          |
|-------------|-------------|----------|------------|----------|
| 1. cycling  | 2. horse    | 3. bed   | 4. Tuesday | 5. ship  |
| 6. calendar | 7. Thursday | 8. curly | 9. map     | 10. ball |

### TEST B

**Exercise 4: Listen and tick the correct photo.** (Nghe và chọn hình đúng).

(Track 17)

- |             |            |          |             |          |
|-------------|------------|----------|-------------|----------|
| 1. painting | 2. honey   | 3. cat   | 4. Sunday   | 5. sleep |
| 6. table    | 7. Tuesday | 8. bench | 9. calendar | 10. frog |

## ROUND 9

### TEST A

**Exercise 4: Listen and tick the correct photo.** (Nghe và chọn hình đúng).

(Track 18)

- |         |          |        |          |           |
|---------|----------|--------|----------|-----------|
| 1. long | 2. sleep | 3. 70  | 4. fork  | 5. shout  |
| 6. wall | 7. rainy | 8. map | 9. heavy | 10. under |

### TEST B

**Exercise 4: Listen and tick the correct photo.** (Nghe và chọn hình đúng).

(Track 19)

- |          |          |           |          |           |
|----------|----------|-----------|----------|-----------|
| 1. short | 2. small | 3. 7      | 4. socks | 5. ball   |
| 6. dog   | 7. money | 8. carpet | 9. shine | 10. below |





## ROUND 10

### TEST A

**Exercise 4: Listen and choose what you hear** (Nghe và chọn phương án em nghe thấy). (Track 20)

1. Where are the desks?
2. Yes, it is. But Tony is stronger.
3. Oh, I love Maths.
4. They're on the boats.
5. It's a new clock.
6. There are two clocks on the wall.
7. I like English very much.
8. Tony is shorter.
9. She's from Canada.
10. Where are the men?

### TEST B

**Exercise 4: Listen and choose what you hear** (Nghe và chọn phương án em nghe thấy). (Track 21)

1. I like English very much.
2. Look at Tom and Tony. Who is taller?
3. We have only four lessons today.
4. It's Monday.
5. We all like juice.
6. She is wonderful.
7. Oh, my sister likes drawing, too.
8. They're in the classroom.
9. How many notebooks are there?
10. What does he look like?





## ROUND 11

### TEST A

**Exercises 4: Listen and choose the correct answer.** (Nghe và chọn đáp án đúng). (Track 22)

1. Every day he gets up at six thirty.
2. It's time to go to bed.
3. Oh, really? My father's a factory worker, too.
4. He watches TV or listens to music.
5. She is nineteen years old.
6. He's a doctor.
7. What time is it now?
8. How many desks are there in the classroom?
9. It's time to go for a walk, Tom.
10. She teaches in a primary school.

### TEST B

**Exercises 4: Listen and choose the correct answer.** (Nghe và chọn đáp án đúng). (Track 23)

1. He works in a hospital.
2. We're late. Let's run.
3. It's time to go back.
4. He's a factory worker.
5. It's time to go for a walk, Tom.
6. What does your mother do?
7. Every day he gets up at six fifteen.
8. She is eight years old.
9. He watches a film or listens to music.
10. She works in a bookshop.



## ROUND 12

### TEST A

**Exercise 4: Listen and tick the correct photo.** (Nghe và chọn hình đúng).  
(Track 24)

- |            |           |             |             |               |
|------------|-----------|-------------|-------------|---------------|
| 1. shorter | 2. taller | 3. hospital | 4. sleep    | 5. run        |
| 6. company | 7. leaf   | 8. candle   | 9. teaching | 10. waking up |

### TEST B

**Exercise 4: Listen and tick the correct photo.** (Nghe và chọn hình đúng).  
(Track 25)

- |            |             |            |               |                |
|------------|-------------|------------|---------------|----------------|
| 1. bigger  | 2. stronger | 3. factory | 4. have lunch | 5. go to bed   |
| 6. factory | 7. hold     | 8. fifteen | 9. eating     | 10. washing up |

## ROUND 13

### TEST A

**Exercise 4: Listen and choose what you hear** (Nghe và chọn phương án em nghe thấy). (Track 26)

1. Farmers work five days a week.
2. Who does he work for?
3. She often plays table tennis at 4:00 p.m.
4. Everyday I get up at five o'clock.
5. On Saturday he usually takes my family to my grandparents'.
6. My father works for a bus company.
7. My brother is a bus driver in London.
8. He has dinner with family at six fifty.
9. When do you go to bed?
10. Tony and Jane go to school at seven.







### TEST B

**Exercise 4: Listen and choose what you hear** (Nghe và chọn phương án em nghe thấy). (Track 27)

1. What does your father do?
2. She leaves for work at seven.
3. The doctor is sitting on a chair.
4. My mother's a doctor. She works in a hospital.
5. Workers work five days a week.
6. Where does she work?
7. She often plays table tennis at 4:30 p.m.
8. Everyday I get up at six o'clock.
9. On Friday he usually takes my family to my grandparents'.
10. My father works for a big company.

## ROUND 14

### TEST A

**Exercises 4: Listen and choose the correct answer.** (Nghe và chọn đáp án đúng). (Track 28)

1. This is a picture of my family.
2. I know all the streets in Hanoi.
3. The work finishes at four fifty.
4. He works for a big company.
5. Lisa has dinner with her family.
6. We don't like hamburgers.
7. They're both drivers in the same company.
8. What does he do after school?
9. My mother is a housewife.
10. He is buying mineral water.

### TEST B

**Exercises 4: Listen and choose the correct answer.** (Nghe và chọn đáp án đúng). (Track 29)

1. He gets home at five thirty in the afternoon.



- 
2. John's father is a worker in Sydney.
  3. You are lovely and friendly too.
  4. I go to school six days a week.
  5. My father is a truck driver, too.
  6. She loves her students and her work.
  7. I live with my family in London.
  8. Lisa has dinner with her family.
  9. We all like hamburgers.
  10. They're both drivers in Jame's company.

## ROUND 15

### TEST A

**Exercises 4: Listen and choose the correct answer.** (Nghe và chọn đáp án đúng). (Track 30)

1. What would you like to drink?
2. This is my silk carf.
3. Coke is her favourite drink.
4. I like beef and chicken.
5. That's my goldfish.
6. Does Jonny like beef very much?
7. I'd like to eat chicken.
8. I'd like to drink lemonade.
9. Linda likes bread with milk.
10. Would you like some noodles?

### TEST B

**Exercises 4: Listen and choose the correct answer.** (Nghe và chọn đáp án đúng). (Track 31)

1. I am thirsty.
2. Does Jonny like fish very much?
3. The fish is on the dish.
4. What's your favourite food?
5. I don't like orange juice.





6. What's your favourite drink?
7. I'd like to eat chicken.
8. The children love milk. It's their favourite drink.
9. What do you like to drink?
10. This is my new cap.

## ROUND 16

### TEST A

**Exercise 4: Listen and choose what you hear** (Nghe và chọn phương án em nghe thấy). (Track 32)

1. She has noodles and milk for her breakfast.
2. Her favourite drink is mineral water.
3. I'd like to eat chicken.
4. Put the words into the right columns.
5. My favourite drink is apple juice.
6. I don't like apple juice.
7. Pork and chicken are my favourite foods.
8. These are my favourite food and drink.
9. What about some apple juice?
10. It's her favourite drink.

### TEST B

**Exercise 4: Listen and choose what you hear** (Nghe và chọn phương án em nghe thấy). (Track 33)

1. Would you like some noodles or meat?
2. I love milk. I drink it everyday.
3. What's your favourite food?
4. Yes, I like it much.
5. What would you like to drink?
6. Is his favourite food chicken?
7. Does Peter like tea?
8. I love milk.





9. These are his favourite food and drink.
10. What about some orange juice?

## ROUND 17

### TEST A

**Exercises 4: Listen and choose the correct answer.** (Nghe và chọn đáp án đúng). (Track 34)

1. What does your teacher look like?
2. What's she like? – She's cheerful.
3. My dad and mum like beef very much.
4. I never forgot my childhood days.
5. Tom's mother is kind and beautiful.
6. The children are friendly.
7. This is my mother. She isn't slim.
8. Is your mother very skinny?
9. Her mother looks sporty.
10. That's my mother over there.

### TEST B

**Exercises 4: Listen and choose the correct answer.** (Nghe và chọn đáp án đúng). (Track 35)

1. She's very nice.
2. My mother looks very strong.
3. My mother is fifty nine years old.
4. He likes dancing very much.
5. Tom's mother is kind and careful.
6. She loves sports.
7. What's your mother's favourite book?
8. My teacher is lovely and kind.
9. What does your sister look like?
10. What's she like? – She's careful.



Sách tham khảo theo chương trình tiếng Anh mới của Bộ GD&ĐT

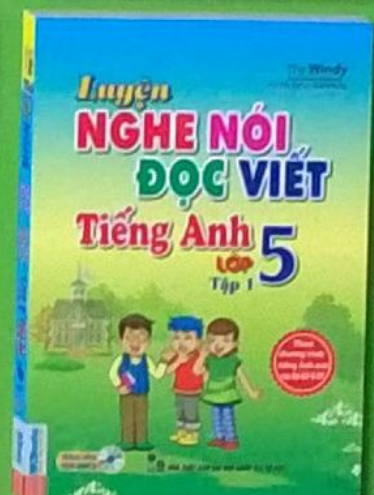
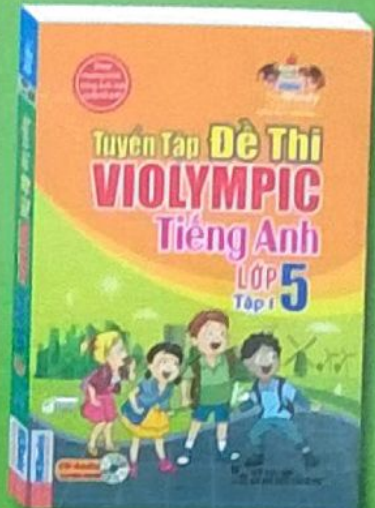
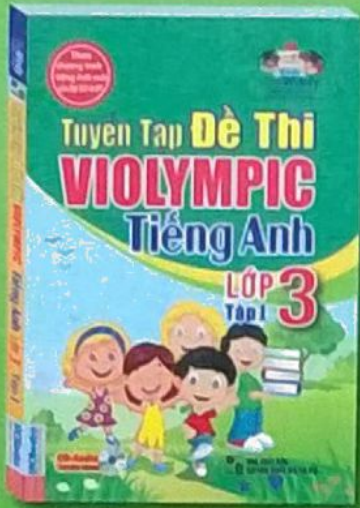

**MCBooks**  
KNOWLEDGE SHARING

26/245 Mai Dịch - Cầu Giấy - Hà Nội \* ĐT: 04.3.792.1466  
Chi nhánh tại TP. Hồ Chí Minh: 45 đường số 8, khu phố 5  
Hiệp Bình Chánh, Thủ Đức, TP.HCM \* ĐT: 0866609398

ISBN: 978-604-62-3475-3



8 935246 903391

**Giá: 82.000 VNĐ**  
**Đã bao gồm CD**